

Do the right  
thing!



2021

## Group Remuneration Policy and Report

# Contents

<b>Letter from the Chairman</b>	<b>4</b>
<b>Highlights</b>	<b>6</b>
<b>Section I. 2021 Group Remuneration Policy</b>	<b>16</b>
1. Overview and principles	
2. Governance	
3. Compliance and Sustainability Drivers	
4. Compensation Framework	
5. Group Compensation Systems	
<b>Section II. Remuneration Report</b>	<b>64</b>
1. Introduction	
2. Governance	
3. Remuneration Processes and Outcomes	
4. 2020 Remuneration Data	

# Letter from the Chairman

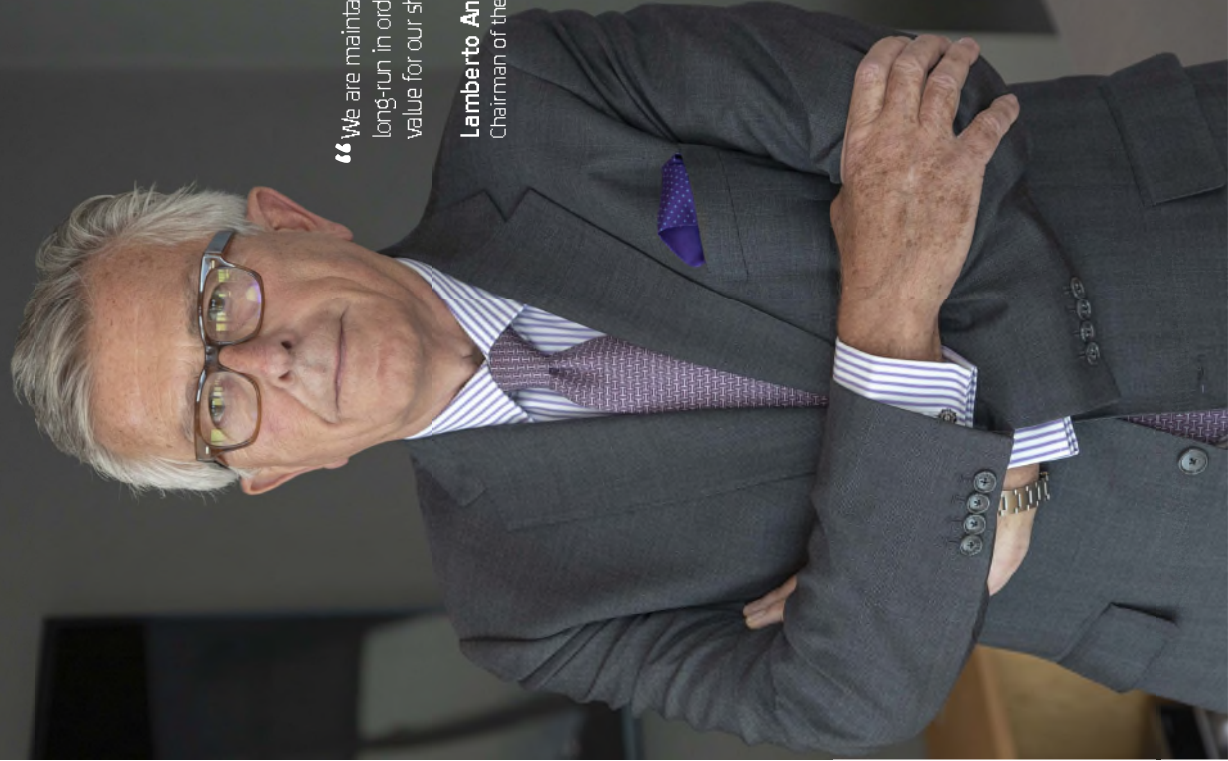

“We are maintaining our focus on the long-run in order to generate sustainable value for our shareholders.”

**Lamberto Andreotti**  
Chairman of the Remuneration Committee

Dear Shareholders,

the pandemic environment is determining deep changes in our approach to daily life. In this context, UniCredit is working for customers, communities and employees playing an active role in this delicate transition period. 2020 was a quite complex year for our Group, the financial system and the entire world. In fact, UniCredit maintained its successful operational response throughout 2020, delivering enhanced customer service, accelerated digital transformation, and Group-wide measures to protect the health, safety and wellbeing of all stakeholders.

Recently, a new designated CEO has been identified and the outgoing Board of Directors has defined the new slate for the formation of the new Board to lead the Group, fostering the success of UniCredit in the long run and reinforcing the areas in which we can grow further, while leveraging on our Group key strengths and the achievements already obtained along the years.

Our remuneration policies will continue to be an integral part of the Group's strategy. Its compensation practices, plans and programs are designed to properly incentivize, in line with market practices, the achievement of the strategic and operational objectives, while ensuring an adequate risk management in accordance with national and international regulatory requirements.

At the same time, shareholders sensitivity, market practices and the regulatory landscape on remuneration in Europe and in the countries where we operate are evolving and we are working to rapidly adapt to these changes. Just to mention a few: the increased focus on sustainability, the gender neutrality and a greater degree of disclosure on remuneration practices.

In this context, we remain committed to maintaining our focus on the long run in order to generate sustainable value for our shareholders.

The Remuneration Committee, together with the Management team, are determined in defining remuneration systems that guarantee sustainable performance at both Group and individual level. At the same time, we are dedicated to providing all colleagues with a best in class work environment and experience and continue setting adequate remuneration levels to attract, motivate and retain the best people.

I would like to renew my gratitude to you, our shareholders, for your engagement in constructive discussions with the Group along the years. These discussions allow us to best understand and address our mutual needs. We will continue to provide you with comprehensive information on our remuneration practices.

Finally, I would also like to thank the other members of the Remuneration Committee for their collaboration and participation to our activities, as well as the personnel in Human Capital who closely cooperated with us.

Sincerely,

**Lamberto Andreotti**  
Chairman of the  
Remuneration Committee

A handwritten signature in black ink, appearing to read 'L. Andreotti'.

# Highlights



# Highlights

*The implementation of the principles set in the Group Remuneration Policy provides the framework for the design of the reward programs across the Group.*

Policy standards ensure that compensation is aligned to business objectives, market conditions and shareholders' long-term interests. UniCredit's compensation approach has been consolidated over time under the Group governance, to be compliant with the most recent national and international regulatory requirements. It is connected to performance, market awareness and aligned with business strategy and shareholders' interests.

The key pillars of the Group Remuneration Policy (Section 1) reflect the most recent regulations in terms of remuneration and incentive policies and practices, in order to build year after year, in the interest of all stakeholders, remuneration systems aligned with long-term strategies and goals as well as a sustainability over time.

The remuneration systems are linked with company results and adequately adjusted in order to take into account all risks, consistent with capital and liquidity levels needed to support all activities and avoid distorted incentives that could lead to breach of law or excessive risk taking.

The 2021 Group Remuneration Policy and Report fully encompasses the changes requested by Circular 285 from the Bank of Italy (25th update of October 23, 2018) on remuneration and incentive matters. In addition, the document includes the requirements of the Legislative Decree no. 49 of May 10, 2019, by which the provisions of Directive (EU) 2017/828 (Shareholder Rights Directive 2) are implemented in the legal system and which introduce an advisory vote by the shareholders' Meeting on the Remuneration Report.



The Group Remuneration Policy continues to be an integral part of UniCredit strategy.

UniCredit is transparent, aims to do the right thing for all stakeholders and favours sustainable long-term outcomes over short-term solutions.

Considering the change of leadership and the 2021 Group Remuneration Policy approval timeline, 2021 can be considered a transition year for what concerns the UniCredit compensation strategy.

In fact, on November 30, 2020, Jean Pierre Mustier announced that he will be retiring from his role as Chief Executive Officer at the end of his mandate.

Subsequently, following a thorough and rigorous selection process, reflecting the Group's commitment to strong corporate governance, on January 27, 2021, the Board of Directors of UniCredit Spa unanimously nominated Andrea Orzel as designated Chief Executive Officer (CEO), for inclusion in the list for the renewal of the Board of Directors, to replace the outgoing CEO, Jean Pierre Mustier.

Following the designation of Mr. Orzel and the approval of the results as at December 31, 2020, the Board has agreed with Mr. Mustier to end his employment relationship as UniCredit's Chief Executive Officer and General Manager - with effect from February 11, 2021.

In order to ensure full managerial continuity, pursuant to Article 21, paragraph 5, of the Articles of Association, the Board of Directors appointed Mr. Ranieri de Marchis as General Manager of UniCredit Spa. Mr. de Marchis will remain General Manager until the appointment of the new CEO.

The Board's slate, including Mr. Orzel as designated CEO, will be presented for approval at the AGM on April 15, 2021. Upon AGM approval of the list, the Board will confirm Mr. Orzel's appointment as CEO and General Manager and, at the same time, the appointment of Mr. de Marchis as General Manager will lapse.

## 1. Key Pillars

- Clear and transparent governance.
- Compliance with regulatory requirements and principles of good business conduct.
- Continuous monitoring of market trends and practices.
- Sustainable pay for sustainable performance.
- Motivation, retention and fair treatment of all employees, with particular focus on talents and mission-critical resources.

[Details](#)  
[Section F-Chapter 1](#) >>>



## 2. Material Risk Takers definition

Application of qualitative and quantitative criteria, which are common at European level, as defined by the regulation, to identify the people who are deemed to take material risks for the organization.

[Details](#)  
[Section F-Paragraph 2.4](#) >>>

The Material Risk Takers population is annually reviewed and on an ongoing basis ensuring full compliance with current regulations. The identification follows a structured evaluation process both at Group and local level, based on the application of qualitative and

quantitative criteria common at European level. The preliminary result of the evaluation process for the definition of Group Material Risk Takers was broadly in line with last year's results.



## 3. Compensation benchmarking and policy target

Confirmed peer group for compensation benchmarking, performed by an external advisor.

Definition of specific peer group at country/division level to assure competitive alignment with the market of reference.

[Details](#)  
[Section F-Paragraph 4.1](#) >>>

With specific reference to the Group Executive population, the Remuneration Committee, supported by an independent external advisor, confirmed the list of selected competitors that represent UniCredit group-level peers for compensation benchmarking. Compensation benchmarking analysis is performed in comparison with this peer group. As a policy target, Material Risk Takers total

compensation is set on the market median as reference, with the possibility to increase (up to market upper quartile) to attract and retain top-class talents, able to improve UniCredit's competitive position, with individual positioning being defined on the basis of specific performance, potential and people strategy decisions, as well as UniCredit's performance over time.



## 4. Ratio between variable and fixed compensation

In compliance with the regulatory requirements, the 2:1 ratio represents the maximum limit between variable and fixed components of remuneration for all employees belonging to business functions, including Material Risk Takers.

[Details](#)  
[Section 4-Paragraph 4.7](#) »

In compliance with applicable regulations, it has not changed - for the personnel belonging to the business functions - the adoption of a maximum ratio between variable and fixed remuneration of 2:1 as approved by the Annual General Meeting of May 13, 2014.

Positions entitled to a variable to fixed ratio of potentially up to a maximum of 2:1 are:

- Group Chief Executive Officer;
- Group Heads and Deputies of Commercial Banking, Corporate and Investment Banking, Chief Operating Office function, Finance & Controls Function;
- CEO and General Managers of Group Legal Entities;
- Personnel belonging to Business Divisions (e.g. Commercial Banking, Corporate and Investment Banking), excluding control or support roles.

Assumptions upon which the increase of the maximum ratio between variable and fixed remuneration, type of personnel and limit itself were based have not changed (e.g. UniCredit business model kept substantially stable since 2014, the compensation strategy is competitive at international level and basically in line with the one in 2014).

This approach allows UniCredit to maintain a strong link between pay and performance, as well as competitiveness in the market.

UniCredit's main peers have also taken the same approach in order to limit the effects of the uneven playing field in the market, where the cap is not present, to avoid the rigidity of the cost structure derived from a possible increase of fixed costs and to guarantee the alignment with multi-year performance, through deferring a relevant component of the variable compensation.

For the rest of the staff a maximum ratio between the components of remuneration equal to 1:1 is usually adopted, except for the staff of the Corporate Control Functions, for Human Resources and the Manager in Charge of Drafting the Company Financial Reports for which it is expected that fixed remuneration is a predominant component of total remuneration. For these Functions is also foreseen that incentive mechanisms are consistent with the assigned tasks, as well as being independent of results from areas under their control.

For these Corporate Control Functions, in particular, the maximum weight of the variable component will take into account the differences between national rules and regulations in application of Directive 2019/878/EU in the various countries in which the Group operates<sup>2</sup>, in order to ensure equal operating conditions in the market and the ability to attract and retain individuals with professional skills and capabilities adequate to meet the needs of the Group.



## 5. Incentive system linked to the annual performance

The Group Incentive System 2021, which confirms the "bonus pool" approach introduced in 2014, provides for a strong link between remuneration, risk and sustainable profitability.

Such a system provides for an overall performance assessment both at Group/country/division level and at individual level.

[Details](#)  
[Section 4-Paragraphs 5.1 and 5.2](#) »

Eight bonus pools whose size is linked to the profitability of each country/division and whose key elements are:

- Entry Conditions: a mechanism that determines the possible application of the malus clause (Zero Factor), based on

performance indicators in terms of profitability, capital and liquidity defined at both Group and country/division level.

- Adjustments to the bonus pools driven by the evaluation of the risk and sustainability for each country/division (alignment to Cost of Capital and Risk Appetite Framework).

1. In particular for the Material Risk Takers, the Corporate Control Functions, in Italy, the ratio between the variable and the fixed components of remuneration cannot exceed the limit of one third as per Bank of Italy provision Circular 285 of December 17, 2013, 28<sup>th</sup> update of October 23, 2018.

- Bonus allocation: once the bonus pools are approved by the Board of Directors, starts the breakdown process to cascade the pools within each perimeter/division. The individual bonus is allocated managerially, taking into consideration the available bonus pool, the individual performance evaluation also based on risk-adjusted indicators and bonus reference values.
- Group Material Risk Takers Payout: the individual bonus is composed of more than 50% in shares for Senior Management and of 50% cash and 50% shares for the remaining Group Material Risk Takers, paid out over a period up to six years, ensuring alignment with shareholders' interests and malus and claw-back conditions, as legally enforceable.



## 6. Performance Management

In 2021 the "KPI Bluebook" framework was reviewed to support managers and incumbents to define the Scorecard referring to the annual Incentive System (as described in the previous paragraph) for the Group Material Risk Takers.

[Details](#)  
[Section 4-Paragraph 5.2](#) »

The KPI Bluebook supports the definition of Scorecards providing a set of performance indicators and guidelines. The categories of the main economic and non-economic indicators, annually defined within the KPI Bluebook, are certified with the involvement of Human Capital, Finance, Risk Management, Compliance and Group

ESG Strategy & Impact Banking functions, which reflect the Group's core operating profitability and risk profile. The KPI Bluebook includes KPIs defined within the scope of the Strategic Plan Team 2.3.



## 7. 2020-2023 Long Term Incentive Plan

The 2020-2023 Long Term Incentive Plan has been introduced in 2020 with the aim to align Top and Senior Management interests to long-term value creation for the shareholders, to share price and Group performance appreciation and sustain a sound and prudent risk management, orienting the performance measurement on a multi-year horizon, aligned with Team 2.3 Strategic Plan.

[Details](#)  
[Section 4-Paragraph 5.3](#) »

The Plan provides for the allocation of incentives based on free ordinary shares, subject to the achievement of specific performance conditions to the Strategic Plan Team 2.3.

The Plan is structured around a 4-year performance period, consistent with the UniCredit Strategic Plan, and provides for the granting of the possible award in 2024.

The award is subject to a 4-year deferral period, after the performance period, and to the respect during the performance period of the minimum conditions of profitability, capital requirements and liquidity as well as positive assessment of Risk Appetite Framework.

In line with regulatory requirements, an additional year of holding period is applied at the end of the deferral period.



## 8. Compliance breach, Malus and Claw-back

The Group reserves the right to a private malus and claw-back mechanisms, namely the reduction/cancellation and the return respectively of any form of variable compensation.

[Details](#)  
[Section 4-Paragraph 5.1](#) »

2. Staff members, which are Senior Management of the legal Entities of Group, Malus as well as all Executive Vice Presidents in the Group legal Entities. This includes, regardless of the holding Group CEO, Heads of Group Business Divisions (e.g. Commercial Banking, C&I, CB&I), Heads of Group Commercial Lines (e.g. Group Compliance Group Human Capital, etc.), Group C&I reporting lines and all other Senior Management roles in Group legal Entities (as defined by Bank of Italy) receiving a significant amount of variable remuneration.

## 11. 2020 results and compensation decisions

### 2020 Results

UniCredit maintained its successful operational response throughout 2020, delivering enhanced customer service, accelerated digital transformation, and Group-wide measures to protect the health, safety and wellbeing of all stakeholders.

The Group delivered underlying net profit of €1.3 billion for FY20, ahead of guidance of above €0.8 billion thanks to better costs, whilst booking €5 billion of loan loss provisions in 2020<sup>6,7</sup>, as it continued to anticipate the current and future economic impact of the Covid-19 pandemic.

The Group's ability to successfully navigate this extraordinary year was underpinned by its diversified business model and its solid financial foundations with a very strong capital and liquidity position and a de-risked balance sheet following proactive and disciplined efforts over the last five years, including a 20 per cent reduction in the cost base since 2015.

For 2021, the ordinary capital distribution will comply with ECB recommendations on dividends issued on 15 December 2020, which for UniCredit limits distributions to €47 million<sup>8</sup> until 30 September 2021. Consequently, a proposal for an ordinary distribution of €268 million in cash and €179 million in share buybacks will be submitted to the AGM<sup>7</sup>.

The extraordinary capital distribution intended for 2021 amounts to €652 million, fully in the form of share buybacks. It will be submitted to the AGM in April 2021, and execution should commence after 1 October 2021<sup>7</sup>. Combining these ordinary and extraordinary distributions, the total capital return to shareholders in 2021 is €1.1 billion, made up of €0.8 billion of share buybacks and €0.3 billion of cash dividends. The cash dividend is subject to AGM approval, while both buybacks are subject to AGM and regulatory approval.

### Compensation decisions

#### Bonus pool performance metrics (pre bonus)

● FY 2019 ● FY 2020 ● % vs 2020 budget

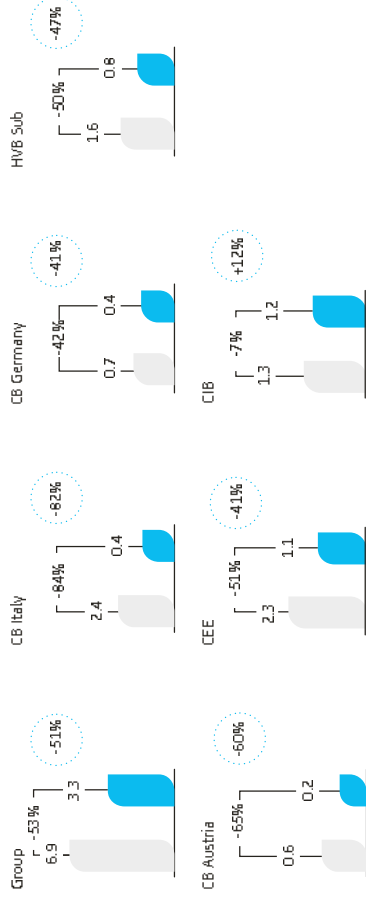

Data in bn euros post performance metrics pre bonus. Underlying Net Operating Profit (Commercial Banking Italy, Commercial Banking Germany, HVB Sub, Commercial Banking Austria, CEE). Underlying Net Operating Profit (Group, Group, C.C. (C.B. % vs. 2020 budget calculated netting out charge effects).

With reference to 2020, the UniCredit Board of Directors considered the proposals of the Remuneration Committee and the ECB recommendations on variable remuneration.

The evaluation regarding compensation decisions, as done before in the previous years, was supported by a rigorous Group governance process in order to guarantee coherence and transparency towards all the participants involved.

- Underlying net profit is the basis for the ordinary capital distribution policy for 2021, as an exception, the ordinary capital distribution will comply with the ECB's proposal for recommendations published on 15 Dec 2020 (ordinary capital distribution) in Italy (€1.272m in 2020), additional rate on deposits (€296m in 2020), capitalised dividend (€157m in 2020), regulatory headwinds impact on CIB (€8 min 2020 - €4m in 2020), €5 min 2020 and €3.5 min in 2020), evaluation of risk assets (€45m in 2020, €7m in 2020) €37m in 2020 and €23m in 2020), Non-Performing Loans in 2020 - €41m in 2020 and €51m in 2020) and Capital Impairment (€878m in 2020).
- Statutory in FY 2020 (€1,999m) based on underlying net profit (€1,300m).
- Statutory in FY 2020 (€1,999m) based on underlying net profit (€1,300m).
- Statutory in FY 2020 (€1,999m) based on underlying net profit (€1,300m).

remuneration components through the application of both malus and claw-back clauses, are reported in the 2021 Group Remuneration Policy.

## 9. Share ownership guidelines

Share ownership guidelines set minimum levels for company share ownership by relevant Executives, by ensuring appropriate levels of personal investment in UniCredit shares over time.

### Details

Section 4-Paragraph 4.8 >>>

The established levels of share ownership should be reached, as a rule, within five years from the appointment in the above indicated Executives categories within the scope of the guidelines and should be maintained until the role is held. The achievement of the share ownership levels should be accomplished through a proactive approach over a 5-year period, granting a minimum amount of shares each year.

The Share Ownership guidelines apply to the Chief Executive Officer, Senior Executive Vice Presidents and Executive Vice Presidents<sup>4</sup>.

## 10. Severance payments

Continuous alignment with regulations/contractual frameworks in force at the time.

Severance payouts take into consideration long-term performance, in terms of shareholders' added value. They do not reward failures or abuses and shall not exceed in general 24 months of total compensation, including notice (in case of lack of law/National Labour agreement provisions as locally applicable).

### Details

Section 4-Paragraph 4.6 >>>

The Ordinary Meeting of April 11, 2019 had approved an update of the Policy on payments to be agreed in case of early termination of a contract (so called "severance payments"), incorporating some changes introduced on October 23, 2018 by the Bank of Italy with the 25<sup>th</sup> update of the Circular 285 of December 17, 2013. Such amendments mainly concerned the introduction of a predefined formula for calculating "severance" for the settlement of current or potential disputes relating to the termination of employment and a better specification of certain elements of detail whilst they did not involve changes with regards to main criteria and limits as already

approved by the Annual General Meeting of April 20, 2017.

On April 15, 2021, a further update is submitted to the Shareholders' Meeting for approval, aimed at reflecting changes in UniCredit's competitive positioning and managing specific remuneration practices in particular situations. The main proposed change provides without prejudice to all the main terms<sup>5</sup> of the current Policy that only the absolute maximum amount is increased from €7.2 million to €15 million in view of the new competitive positioning.

- Bank of Italy Circular 285 on "Indicators and practices on remuneration and incentive" updated as of October 23, 2018 and Bank of Italy "Guidelines on sound remuneration policies" published on 15 Dec 2020.
- Considering the application from 2016, of the ratio between the variable and the fixed components of remuneration (which cannot exceed the limit of one third for the total risk takers with individual credit ratings, with the exception of the variable component for the Credit Functions or other categories), the remuneration guidelines in particular that severance pay, including notice shall not exceed 20 months of fixed remuneration, that the additional portion of notice shall, in no case, exceed 18 months remuneration and that the absolute maximum limit of severance pay shall remain at 6 times fixed remuneration with no possibility of exceptions.

Consistently with the ECB letters of May 20, July 28 and December 15, 2020 requiring for extreme moderation with regard to the variable remuneration payments, especially for Material Risk Takers, the 2020 bonus decisions consider a reduction of ca. 50% in the bonus of Group Material Risk Takers compared to budgeted figures with a proportionally higher reduction for senior executives.

In line with Group governance, assessment and payment for the Executives with Strategic Responsibilities have been reviewed by the Remuneration Committee and approved by the Board of Directors, heard the Statutory Auditors and Internal Controls & Risks Committee where appropriate.

The Board of Directors approved the overall bonus pool. The proposal submitted to the Board emerged in total bonus pool amount broadly

**2020 Bonus distribution for GMRT**

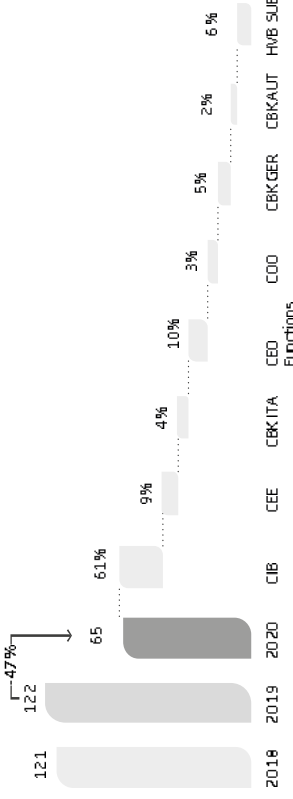

Data in millions. The 2020 payout does not include the 111 private yearly quota.

in line with the total theoretical value (depending on the funding KPI) which was highly affected by pandemic, mostly as a result of balancing per-capita bonus levels and performances within each country/division. Here below it is shown the distribution of the bonus for the Group Material Risk Taker population (1,063 resources), defined on the basis of the application of the 2020 Group Incentive System rules approved by the Shareholders' Meeting.

Considering the uncertain impact on the European economy of Covid-19 epidemic and its evolution over time, Top 7 Senior Managers reporting to the CEO decided to voluntarily waive their 2020 annual bonus, in line with the decision taken by the CEO to fully waive his yearly variable compensation and 25% of his salary for the year 2020.

## 12. Chief Executive Officer variable and fixed compensation data

In April 2020, Jean Pierre Mustier announced that, in addition to foregoing his full variable 2020 LTP remuneration, equivalent to a maximum of 24 million Euro, has proposed to reduce his 2020 salary by 25 per cent, equivalent to 300,000 Euro. The total reduction of the CEO's compensation was thus 2.7 million Euro, which the Board of Directors, donated with immediate effect, to the UniCredit Foundation to alleviate the impact of the pandemic on local communities and provide extra resources to the health services in their fight against the virus.

On November 30, 2020, Jean Pierre Mustier announced that he will be retiring from his role as Chief Executive Officer at the end of his mandate. While defining the exit conditions, it was agreed that he will only maintain the variable remuneration deriving from the 2017-2019 Long Term Incentive Plan, which shares will be awarded according to the vesting scheme and subject to malus and claw-back conditions, as legally enforceable.

In line with the 2021 Group Remuneration Policy, the CEO remuneration framework is based on a fixed compensation defined between market median and upper quartile of the UniCredit EU peer group.

The CEO position, in line with the May 13, 2014 AGM decision, has a maximum variable remuneration of 200% of fixed compensation. In order to foster the alignment of the interests between the designated CEO and the shareholders, already in the first year in the role, the Board of Directors has approved a share-based award, representing the full variable remuneration for 2021, payable in two tranches, not subject to performance conditions, malus or claw-back, while subject to minimum prudential requirements at the time of payment, therefore allowing him to be compliant with the Group share ownership guidelines.

The proposed remuneration structure for 2021 is strictly linked to the first year of the mandate. For 2022 onwards a mix of performance based long-term and short-term incentives will be applied to the CEO.

The remuneration package does not include any remuneration aimed at compensating Mr. Oref for the possible reduction or cancellation of remunerations deriving from previous employments (so called "buy out" as regulated under Circular 285/13 of Bank of Italy).

Details on the 2021 CEO compensation amounts will be provided in Section II of the 2022 Group Remuneration Policy and Report according to Consob requirements.

### Compensation disclosure

The Remuneration Report (Section II) provides the description of UniCredit's compensation practices and the implementation outcomes of Group Incentive Systems, as well as remuneration data with a focus on non-executive Directors and Group Material Risk Takers, defined in line with regulatory requirements.

Full disclosure on compensation payout amounts, deferrals and the ratio between variable and fixed components of remuneration for Group Material Risk Takers is provided in the Remuneration

Report (paragraph 4.2, Granular Remuneration Data), including data regarding Directors, General Managers and other Executives with Strategic Responsibilities.

Data pursuant sect. 84-quarter Consob Issuers Regulation Nr. 11971, Compensation Report-Section II (last modified under resolution no. 21623 of December 10, 2020), as well as the information on incentive systems under 114-bis of legislative decree 58/1998 ("Testo Unico della Finanza" - "TUF") are included in the attachments to the 2021 Group Remuneration Policy and Report, published on UniCredit's website, in the section dedicated to 2021 Shareholders' Meeting.

[Details](#)  
[Section II-Paragraph 4.2](#) >>>



# 2021 Group Remuneration Policy

- 1. Overview and principles**
  - 1.1 Remuneration Policy alignment to sustainability strategy
  - 1.2 Employees working conditions, integral part of the remuneration policy
  - 1.3 Shareholders vote and main changes introduced with the 2021 Group Remuneration Policy
- 2. Governance**
  - 2.1 Corporate Bodies and Committees
  - 2.2 Definition of the Group Remuneration Policy
  - 2.3 Role of the Corporate Control Functions
  - 2.4 Material Risk Takers identification process
  - 2.5 Compensation to Directors, Statutory Auditors and Executives with Strategic Responsibilities

- 3. Compliance and Sustainability Drivers**
- 4. Compensation Framework**
  - 4.1 Continuous Monitoring of Market Trends and Practices
  - 4.2 Fixed compensation
  - 4.3 Variable compensation
  - 4.4 Non-standard compensation
  - 4.5 Benefits
  - 4.6 Severance
  - 4.7 Ratio between variable and fixed compensation

- 5. Group Compensation Systems**
  - 5.1 2021 Group Incentive System
  - 5.2 Performance Management framework
  - 5.3 2020-2023 Group Long Term Incentive Plan

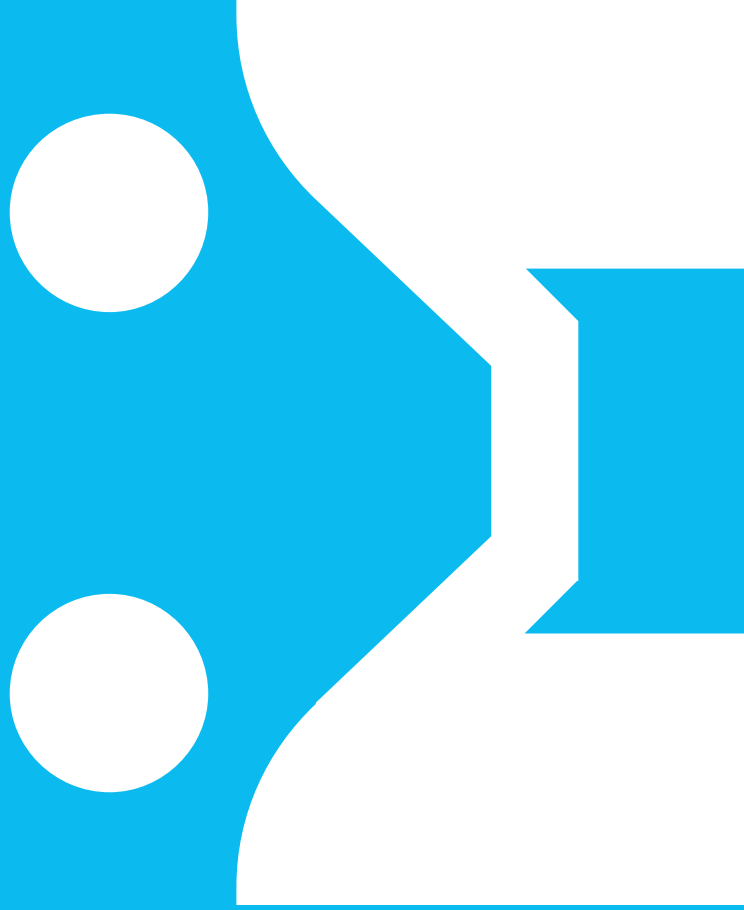

# 1. Overview and principles

*The set of values of UniCredit is based on ethics and respect as sustainable conditions to transform profit into value for stakeholders. A simple guiding principle ensures we live these values every day: do the right thing!*

By upholding the standards of sustainable behaviors and values which drive the Group's mission, the compensation strategy represents a key enabler to enhance and protect its reputation and to create long-term value for all Group stakeholders.

Specifically, the remuneration policy contributes to the business strategy, long-term interests and the sustainability of UniCredit.

More than ever, sustainability forms a central part of everything UniCredit does and is fully integrated into the business and decision-making process: commitment to ESG topics, renewed focus on improving customer experience and constant dedication to the people. It is a key lever for the future business strategies and a critical component of the bank's success.

Through appropriate compensation mechanisms, UniCredit aims to create a best-in-class work environment, fostering and unlocking individual potential in order to attract, retain and motivate a highly qualified global workforce capable of creating a competitive advantage for the Group. Are rewarded those who reflect the standards of ethical behavior in conducting business in a sustainable way.

UniCredit believes in inclusion as a strategic business driver and is committed to creating an inclusive environment for its diversified workforce, where everyone with the capability to excel can do so. The employees are expected to contribute to creating

and maintaining a work environment that is respectful and non-intimidating, and where differences in age, race, nationality, religion, gender and sexual orientation are embraced and promoted.

Relying on the governance model of UniCredit, the Group Remuneration Policy sets the framework for a coherent and consistent design, implementation and monitoring of compensation practices across the entire Group.

Within this common policy framework, guidelines are defined to implement compensation programs and plans that reinforce sound risk management policies and the long-term strategy, and generally pursue long-term value creation and sustainability of the company. In doing so, the Group effectively meets the specific and evolving needs of the different businesses, market contexts and employee populations while ensuring that business and people strategies are always appropriately aligned with the remuneration approach, including external networks and agents, where applicable, as foreseen by regulation.

To ensure the competitiveness and effectiveness of remuneration as well as transparency and internal equity, the principles of sustainable conduct and performance define the key pillars of the Group Remuneration Policy.

## Key Pillars

Clear and transparent governance, through efficient corporate and organizational governance structures, as well as clear and rigorous governance and rules.

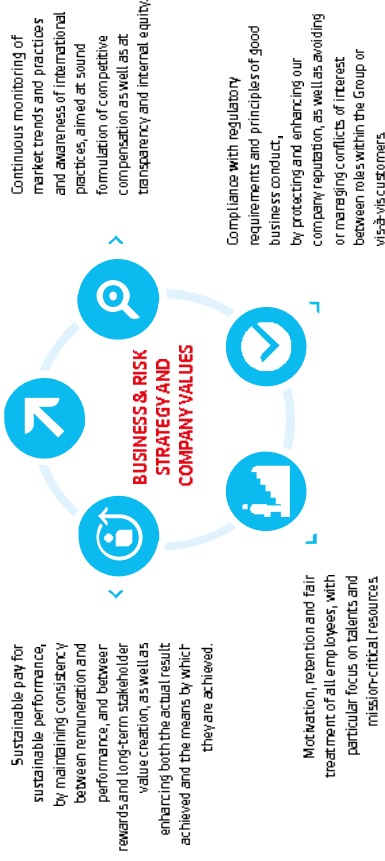

## 1.1 Remuneration Policy alignment to sustainability strategy

In UniCredit value creation means more than just generating financial values. It also means integrating sustainability into the business strategies in terms of human capital, society and environment.

In the fourth quarter of 2019, UniCredit announced new ESG targets as part of the long-term commitment to sustainability – part of the Group's DNA and a key component of the business model of UniCredit. Building a sustainable future is an important challenge for both people and businesses. Every company has to do more than "business as usual" - it is time to act and make an impact. Please also refer to the Integrated Report available on the corporate website for further details on the Sustainability Strategy in UniCredit.

The remuneration policy contributes to the UniCredit strategy, the pursuit of long-term interests and the sustainability overtime. UniCredit has in place a remuneration structure that is based on risk-adjusted/related performance and does not encourage excessive risk-taking, including with respect to sustainability risks.

Also, one of the pillars of the Group Remuneration Policy addresses the sustainable pay for sustainable performance, by maintaining consistency between remuneration and performance, and between rewards and long-term stakeholder value creation, as well as enhancing

both the actual result achieved and the means by which they are achieved.

Several processes and initiatives support the link between the remuneration policy and the sustainability.

The 2020-2023 LT Plan aims at aligning Top and Senior Management interests to the long-term value creation for the shareholders. The LT Plan, aligned with Team 2.3 Strategic Plan, has a Sustainability lever weighting 10% of the overall Scorecard to increase the alignment of business goals with sustainable conduct. The KPIs considered - ESG rating, Customer Satisfaction and People Engagement - assure a balance between how UniCredit is perceived by employees and customers and what is an ESG rating agency's view of UniCredit. For further details on the link between the LT Plan and the sustainability, please refer to the paragraph 5.3 2020-2023 Group Long Term Incentive Plan.

The Group Incentive System is supported by the annual performance management assuring coherence, consistency and clarity of performance objectives with business strategy. The process of setting annual objectives (so-called Goal Setting) is a key phase and is

supported by a structured framework, namely **KPI Bluebook**. The KPI Bluebook, reviewed and updated annually, with the involvement of relevant Group key functions, is a dashboard of Group certified KPIs, mandatorily to be utilized for assigning goals to the Group Material Risk Takers, and allows for consistent goal setting with regulatory requirements and Group standards.

The Goal setting structure considers economic goals and non-economic goals and is characterized by:

- at least one goal flagged as risk adjusted/related;
- around half of the goals flagged as sustainable/long term related (i.e. Tone from the Top to spread compliance and risk culture, "Ethics and Respect", values and staff integrity and Human Capital Value & Inclusion, which addresses the gender balance and pay equity, as well as the safety and wellbeing of employees and the transition towards remote working);
- specific KPIs on "Environment", based on ESG Strategy commitment, added to Strategic Plan Delivery goal, such as reducing environmental impact through carbon emissions reduction and use of renewable energy, as well as expanding ESG product/advisory offering;
- renewed focus on Diversity & Inclusion, embedded in "Human Capital Value & Inclusion" (i.e. Gender pay gap/balance targets, gender diversity initiatives).

Goals represent "what" to achieve to contribute to UniCredit's business strategy success, while the behaviors acted to achieve them represent the "how".

In this regard, UniCredit capabilities describe the behaviors UniCredit expects from people to support and meet Group ambitious goals

## 1.2 Employees working conditions, integral part of the remuneration policy

UniCredit People Strategy is focused on supporting the continuous development of its people and ensuring a positive working environment where all employees feel engaged and are committed to value creation.

The Welfare offer is based on four key Group pillars, namely Work-life balance, People caring, Well-being and Social reputation to support colleagues at all stages of their lives. It represents an important solution for colleagues, even more since the Covid-19 health emergency outbreak, supporting colleagues throughout their personal, family and professional challenges.

Welfare initiatives are locally developed and implemented in order to offer the right answer to each country's needs and special requirements,

and respond to the stakeholders' needs "doing the right thing", guaranteeing a homogeneous and unique standard for people evaluation, at all levels in the Group. The UniCredit Capabilities (two for each of the Five Fundamentals) indicate the behaviors colleagues should demonstrate while working towards their goals, clarifying expectations about how to apply Five Fundamental and Ethics & Respect values in their daily activities and reach individual and team results in a responsible manner.

[Details >>>](#)

*For further details, please refer to the paragraphs 5.2, 2021 Group Incentive System and 5.2 Performance Management Framework.*

Finally, the diversity and inclusion policies are a cornerstone of the human capital strategy of UniCredit's business model, which has successfully delivered value creation over time. Promoting gender equality and inclusion is a way to improve the well-being of individuals and make the business strategies more sustainable in the long-term.

Within the framework provided by the Group Remuneration Policy, UniCredit is committed to ensure fair treatment in terms of remuneration on the basis of the role covered, the scope of responsibilities, performance outcomes and the overall quality of the contribution to business results, regardless of gender or any other diversity traits.

For years now, UniCredit has developed a methodology to evaluate and to monitor gender pay gap which results are presented and discussed in the Diversity & Inclusion committees. This methodology is valid for the whole Group. Moreover, specific targets on gender pay gap/balance and on gender diversity initiatives have been assigned to Top Management. Additionally, since 2017 UniCredit publishes the UK GPG as requested by the Gender Pay Gap Regulations in Great Britain.

while maintaining a central coordination to guarantee respect of the Group Welfare principles and guidelines.

Several tailor-made initiatives to meet fundamental health and family needs have already been established in most countries across the Group. UniCredit supports families with solutions such as flexible and parental leaves, extensive services networks with qualified partners for family caring, financial support for employees with young children and family members with disabilities.

Social dialogue creates a balance between workers' needs and business needs, by constantly verifying the continuity of initiatives and progress of projects over time. This innovative approach is the basis for Joint Declarations between UniCredit and European Works Council on topics

engaging and retaining talented people, by caring on cross-country initiatives to ensure an equal treatment for all employees.

The Welfare offer is an integral part of the total reward for UniCredit colleagues and an important pillar of the People Strategy. As a recognition of the effectiveness of its People Strategy, UniCredit has been officially certified as a Top Employer in Europe in 2021 for the fourth year running for its employees offering in terms of Work Environment, Talent Acquisition, Learning Wellbeing and Diversity & Inclusion.

For further details, please refer also to UniCredit Integrated Report available on the corporate website where additionally to welfare policies also information on training programmes and development plans and initiatives promoting diversity & inclusion are available.

## 1.3 Shareholders vote and main changes introduced with the 2021 Group Remuneration Policy

- ex-ante and ex-post risk adjustment:

- Material Risk Takers identification process and methodology, considering the new EBA Regulatory Technical Standards;

- the update of the Entry Conditions within the Group Incentive System, in line with the yearly evolution of RAF limits for capital and liquidity ratios;

- the introduction of a "gate" on MIFID Customer Profiling to bonus payout, to further strengthen the framework to mitigate the risk of missing collection or updating of the MIFID interview;

- a new minimum 4-year deferral scheme (replacing the previous 3-year deferral scheme) for non-Senior Management, in line with the CRD V provisions;

- alignment of remuneration policy governance rules to new Consob Issuers Regulation provisions transposing in Italy the Shareholders Rights Directive II EU provisions;

- introduction of a procedure to be applied in case a derogation to elements of the remuneration policy is required, as foreseen by art. 123-ter of TUF, to ensure the long-term sustainability of the Group;

like Equal opportunities and non-discrimination, Responsible Sales and Work-life balance.

Additionally, in 2020 the UniCredit Family Board was established with the aim to coordinate a global action plan to be locally implemented focusing on flexibility, psycho-physical wellbeing, home-schooling support and new ways of working.

Actions were diversified and included: home-schooling/work IT infrastructure and furniture partnership extensions; mobility solutions; online resources on sport, entertainment, elderly members of the family, children with disabilities, etc.; support programmes for parents, children and caregivers to increase awareness, change management (e.g. webinars, digital masters); psychological support services; parental leaves.

The final aim is to consolidate UniCredit's unique identity across the Group as "best place to work" and actively contribute in attracting,

The feedback gathered during the shareholders' Annual General Meeting held on April 9, 2020 on the 2020 Group Remuneration Policy was positive, with an approval percentage higher than 95%.

Answers have been provided to all questions received from the shareholders in order to allow them to better express their vote, as happens throughout the year.

UniCredit has in place for years now a consolidated engagement process with the international investors and proxy advisors which has the aim to share and constructively exchange views on the changes brought to the Policy. Over the years this dialogue enabled to receive valuable feedback on the compensation approach as well as to verify the alignment with international best practices and investors' expectations.

Considering the change of leadership and the 2021 Group Remuneration Policy approval timeline, 2021 can be considered a transition year for what concerns the UniCredit compensation strategy.

Nonetheless, 2021 Group Remuneration Policy main changes are driven by the aim to ensure the remuneration strategy may attract Directors, Executives and key people for the long-term objectives of the Group, while complying with the latest regulatory updates. In particular:

- review of the compensation policy target for Material Risk Takers related to the total compensation which is set on the market median as reference, with the possibility to increase (up to market upper quartile) to attract and retain top-class talents;

1. The Five Fundamentals are Customised, People Development, Cooperation & Synergies, Risk Management, Execution & Discipline. The Five Fundamentals are the main pillars of UniCredit culture and are the basis of the UniCredit Competency Model that describes these behaviors that are expected from UniCredit people and through which all employees are assessed in performance management process.

## 2. Governance

The UniCredit compensation governance model aims to assure clarity and reliability of remuneration decision-making processes by controlling Group-wide remuneration practices and ensuring that decisions are made in an independent, informed and timely manner at appropriate levels, avoiding conflicts of interest and quarantining appropriate disclosure in full respect of the general principles defined by regulators.

### 2.1 Corporate Bodies and Committees

#### 2.1.1 Role of the Remuneration Committee

In order to foster an efficient information and advisory system to enable the Board to better assess the topics for which it is responsible, pursuant to the Supervisory Authority provisions on corporate governance issued by the Bank of Italy and with the ones of the Corporate Governance Code of Listed Companies ("Corporate Governance Code"), the Remuneration Committee has been established by the Board, vested with research, advisory and proposal-making powers.

In particular, the Remuneration Committee is entrusted with the role of providing advice, opinions and proposals submitted to the Board of Directors with regard to the Group remuneration strategy. The Remuneration Committee relies on the support of internal corporate functions and, in particular, of Group Human Capital, Group Risk Management and Group Compliance functions, respectively for the topics under their scope. In particular, the Group Chief Risk Officer is invited, upon need, to attend Committee meetings to ensure that incentive schemes are appropriately updated to take into account all of the risks that the Bank has taken on, pursuant to methodologies in compliance with those adopted by the Bank in managing risk for regulatory and internal purposes.

Moreover, the Committee avails itself of the support of Willis Towers Watson as external advisor to ensure that remuneration and incentive systems embed the Bank's risk, capital and liquidity profiles (e.g. regarding the remuneration policy for corporate officers) as well as constantly updated on the market evolution, remuneration dynamics and regulatory framework.

The Remuneration Committee was founded in 2000. The members of the Remuneration Committee, which was instituted based on the above mentioned Bank of Italy supervisory arrangements and also in line with the Code's provisions, are all non-executive and the majority of them independent.

The Committee consists of three non-executive and independent members pursuant to the Corporate Governance Code, the Articles of

Association and art. 148, paragraph 2, of TUF (the Consolidated Law on Finance). The activities of the Committee are coordinated by the Chairman, chosen among them.

All members meet the requirements of professionalism, in accordance with current normative and regulatory dispositions and ensure that any further corporate offices they hold in other companies or bodies (including foreign ones) are compatible with the commitment and availability required to hold the office of member of the Committee. Some members have specific technical know-how and experience on financial matters or remuneration policies.

The consistency with Risk Appetite Framework and, in general, the collaboration with the other committees are ensured by the presence, in the Remuneration Committee, of one member of the Internal Controls & Risks Committee.

The Committee appoints - on the proposal of the Chairman - a Secretary who is not a member of the Committee itself. The Secretary supports the Chairman of the Committee in the preparation of the meetings and takes care of the minutes. In addition, the Head of Group Human Capital (or his delegate) attends the Committee meetings and, when necessary based on the topic discussed, the members of Senior Management team (e.g. the Head of Group Risk Management, the Group Chief Financial Officer or the Head of Internal Audit) may be invited as well.

Moreover, the Committee members regarding whom the Committee is called upon to express its opinion on their remuneration as a result of their specific assignments shall not attend meetings at which the proposals for such remuneration is determined.

The Chairman of the Remuneration Committee at the earliest available meeting informs the Board of Directors about the activities carried out in the meetings by the Committee itself.

The Remuneration Committee shares, at the end of their meetings, the discussed documentation with the Board of Statutory Auditors, without prejudice to the possibility for the Statutory Auditors to attend the meetings.

- enhanced evidence on the links among the remuneration policy, the corporate sustainability and ESG;
- disclosure regarding the changes in individual compensation for governance bodies members, Group performances and employee's average remuneration and related working conditions;

#### FOCUS

##### Global Job Model

The Global Job Model is an organizational system that describes, standardizes and calibrates all jobs within UniCredit. Moreover, it supports the management of people and processes at global level in a simple, easy to understand and consistent way. Based on market practice, it is aligned with our business needs.

Global Job Model consists of two key elements: Global Job Catalogue and Global Banding Structure. The latter is made of 9 global bands, the three highest bands are:

- Band 8: Group Chief Executive Officer;
- Band 7: Senior Executive Vice Presidents (SEVP), having responsibility for determining the Group business strategy and a strong influence on it, determining or strongly influencing decisions that will impact on the entire organization and having direct responsibility for a core part of the Group. As a general rule, the SEVPs are first or second reporting lines to the CEO;

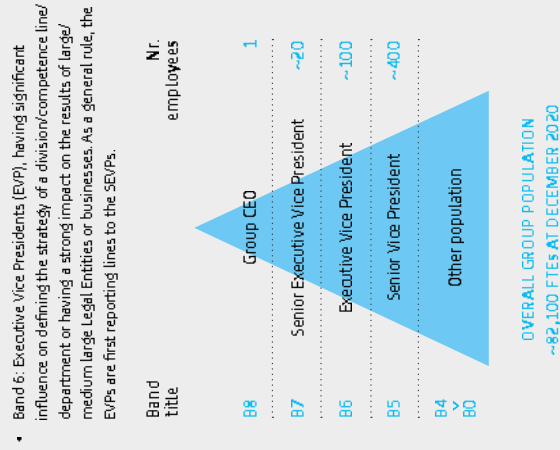

The "standard" topics discussed along the year are:

- January:
- Yearly Group Incentive System;
  - Report on previous year severance payments;
- February:
- Bonus pool distribution including approval of capital increase related to previous years incentive plans;
  - Evaluation, payout and execution of previous years plans for Executives with Strategic Responsibilities<sup>2</sup>;
  - IRI status progress and individual allocation;
- March:
- Previous year Group Incentive System payout;
  - Group Remuneration Policy and Report;
- June:
- Group Material Risk Takers – assessment methodology and outcomes;

- July:
- Gender Neutral Remuneration;

- October:
- Local Adaptations to Group Remuneration Policy;
  - Previous year Bonus Payout and Group Salary reviews final update;
- November:
- Emerging trends in Market Compensation Practices;
  - Competitive assessment of compensation package for CEO and Executives with Strategic Responsibilities;
  - Goal Setting for the upcoming year for Executives with Strategic Responsibilities;
- December:
- Group Material Risk Takers – Final Outcome;
  - Compensation review for Executives with Strategic Responsibilities;
  - Preliminary discussion on Bonus pool distribution.

## FOCUS

Within the scope of its responsibilities, the Remuneration Committee:

- puts proposals to the Board regarding the remuneration and the performance goals associated with its variable portion, for the members of the Board of Directors, the General Manager, Deputy General Managers, Heads of the corporate control functions and personnel whose remuneration and incentive systems are decided upon by the Board;
- exercises oversight on the criteria for remunerating the most significant employees, as identified pursuant to the relevant Bank of Italy provisions, as well as on the outcomes of the application of such criteria;
- issues opinions to the Board of Directors on the remuneration policy for Senior Executive Vice Presidents, the Group Management Team (Executive Vice Presidents) and the Leadership Team (Senior Vice Presidents);
- issues opinions to the Board of Directors on the Group incentive schemes based on financial instruments;
- issues opinions to the Board of Directors on the remuneration policy for corporate officers (members of Board of Directors, Board of Statutory Auditors and Supervisory Board) at Group companies;
- coordinates the process for identifying Material Risk Takers on an on-going basis;
- directly oversees the correct application of rules regarding the remuneration of the Heads of Corporate Control Functions, working closely with the Board of Statutory Auditors;
- works with the other committees, particularly the Internal Controls & Risks Committee, to verify that the incentives included in compensation and incentive schemes are consistent with the Risk Appetite Framework (RAF), ensuring the involvement of the corporate functions responsible for drafting and monitoring remuneration and incentive policies and practices;
- provides appropriate feedback on its operations to the Board of Directors, Board of Statutory Auditors and the Shareholders' Meeting;
- where necessary drawing on information received from relevant corporate functions, expresses its opinion on the achievement of the performance targets associated with incentive schemes, and on the other conditions laid down for bonus payments.

<sup>2</sup> Please consider the final line and topics as indicative as they vary from year to year. In addition, non-ordinary topics are shown

<sup>3</sup> The Executive with Strategic Responsibilities are those who have power and responsibility, in whole or in part, for the planning, direction and control of the activities of the company, including the directors (executive or otherwise) of the company, staff or other officials of the company, or subsidiaries, or subsidiaries of the company.

### 2.1.2 Role of the Internal Controls & Risks Committee

The Internal Controls & Risks Committee supports the Board of Directors on risk management and control-related issues. The Internal Controls & Risks Committee, among the other tasks:

- without prejudice to the competencies of the Remuneration Committee, checks that the incentives underlying the remuneration and incentive system comply with the RAF, particularly taking into account risks, capital and liquidity;
- for the Head of Internal Audit function, issues its opinion on setting the remuneration and the performance goals associated with its variable portion in line with the company policies;
- is involved, within its specific remit, in the process of identifying Material Risk Takers on an on-going basis.

### 2.1.3 Role of the Board of Statutory Auditors

Within the "traditional" management and control system UniCredit has adopted, the Board of Statutory Auditors is responsible for overseeing the effective administration of the company. The Board of Statutory Auditors, among the other tasks:

- is consulted with regards to the remuneration of UniCredit's Directors holding specific roles with a special focus on the remuneration of the CEO and the approval of Group financial instrument-based incentive schemes;
- issues a mandatory opinion on the appointment, dismissal and compensation of the Manager in charge of drafting company financial reports;
- expresses its opinion on decisions regarding the appointment and dismissal of the Heads of Corporate Control Functions;
- expresses an opinion regarding the remuneration of the Head of Internal Audit in coherence with company policies.

### 2.1.4 Role of the Related-Parties Committee

The Committee operates on a consultative and proposition-making basis in support of the Board of Directors. The Committee oversees issues concerning transactions with related parties pursuant to Consob Regulation no.17221/2021 and transactions with associated parties pursuant to Bank of Italy Circular no. 285/2013, carrying out the specific role attributed to independent directors by the aforementioned provisions.

With regard to remuneration in favor of persons qualifying as related parties, it should be noted that the provisions of Consob Regulation 17221/2021 and Bank of Italy Circular no. 285/2013 do not apply to:

- shareholders' resolutions pursuant to art. 2389, paragraph 1 of the Italian Civil Code, relating to the remuneration of members of the Board of Directors, as well as to the resolutions concerning the remuneration of Directors vested with special duties falling within the overall amount previously determined during the Shareholders' Meeting pursuant to art. 2389, paragraph 3 of the Italian Civil Code;
- shareholders' resolutions pursuant to art. 2402 of the Italian Civil Code, relating to the remuneration of members of the Board of Statutory Auditors;
- remuneration plans based on financial instruments approved by the Shareholders' Meeting pursuant to art. 114-bis of Legislative Decree no. 58 of 1998 and their implementation;
- resolutions, other than those referred to at art. 2389, first paragraph of the Italian Civil Code, concerning the remuneration of the Directors vested with special duties, and the other Executives with strategic responsibilities provided that: i) UniCredit S.p.A. has adopted a remuneration policy approved by the Shareholders' Meeting; ii) the Remuneration Committee of UniCredit S.p.A., consisting exclusively of non-executive, mostly independent, Directors, was involved in the definition of the remuneration policy; iii) the remuneration awarded is identified in accordance with this policy and quantified on the basis of criteria that do not involve discretionary assessments.

With regard to remuneration, the Related Parties Committee is involved, for the profiles of its own competence, in the preliminary investigation concerning:

- transactions that do not benefit from the above-mentioned exemptions and/or other applicable exemptions;
- temporary exceptions to the remuneration policy that the Company intends to implement in the presence of exceptional circumstances (see paragraph 2.2).

## 2.2 Definition of the Group Remuneration Policy

On an annual basis, the Group Remuneration Policy, as proposed by the Remuneration Committee, is defined by the Board of Directors, and then presented to the shareholders' Annual General Meeting for approval, in line with regulatory requirements.

In particular, the Group Remuneration Policy is drawn up by the Group Human Capital function with the involvement of the Group Risk Management and other relevant functions (e.g. Group CFO) and is validated by the Group Compliance function for all compliance-related aspects, before being submitted to the Remuneration Committee. Once approved at the UniCredit Annual General Meeting, the Group Remuneration Policy is formally adopted by competent bodies in the relevant Legal Entities across the Group in accordance with applicable local legal and regulatory requirements.

The principles of the Group Remuneration Policy are valid across the entire organization and shall be reflected in the remuneration practices applying to employee categories across businesses, including staff belonging to external distribution networks, considering their remuneration peculiarities.

With specific reference to Group Material Risk Takers, the Group Human Capital function establishes guidelines and coordinates a centralized and consistent management of compensation and incentive systems.

In compliance with Group Remuneration Policy and local regulation, Legal Entities, countries and divisions apply compensation framework for all employees.

Furthermore, the elements of the Policy are fully applied across the entire Material Risk Taker population, with local adaptations based on specific regulations and/or business specifics, consistent with the overall Group approach.

Being fully compliant with the principles of the incentive plans, local adaptations allow the achievement of the same results if the implementation of the Group plan should have some adverse effects (legal, tax or other) for the Group companies and/or beneficiaries residing in countries where the Group is present.

Implementation of Group incentive plans for Group Material Risk Takers fully complies with Bank of Italy requirements and European Guidelines, and at the same time considers:

- local needs to adopt alternative solutions as necessary according to local regulators;

- Audit out comes, in each jurisdiction, on the implementation of the incentive systems;

- further needs to introduce corrective measures to address local specificities, with focus on the reconciliation of local differences and home/host regulatory roles.

The main adjustments regarding the implementation of the Group Policy usually concern the use of financial instruments different from the UniCredit shares, the thresholds and deferral schemes, local performance indicators rather than the Group ones, the ratio between variable and fixed remuneration, malus and claw-back procedure, considering an alignment to the regulatory provisions and local peculiarities.

As provided for by Legislative Decree 49/2019, which transposed the Shareholders Rights Directive II into the legal system by amending the Consolidated law on Finance (TUF), in force since June 2019, UniCredit may, in exceptional circumstances, temporarily derogate from the remuneration policy.

Exceptional circumstances shall cover situations that can be traced back to the general cases provided for by art. 123 ter of TUF, namely in which the derogation from the remuneration policy is necessary to serve the long-term interests and sustainability of the company as a whole or to assure its viability.

In the event of such exceptional circumstances, the Board of Directors, as proposed by the Remuneration Committee and subject to reasoned favorable opinion of the Related Parties Committee (issued in accordance with the Global Policy on transactions with related parties, associated persons and corporate officers pursuant to art. 136 TUB, irrespective of whether there is an exemption under the Global Policy in this case), may resolve on specific temporary derogations, without prejudice to compliance with legal and regulatory constraints, limited to the contents of the Remuneration Policy related to: (i) the reference pay-mix CEO, General Manager and Executives with Strategic Responsibilities; (ii) the reference peer group; (iii) the economic parameters of the Group Incentive System and the Group Long-Term Incentive Plan.

UniCredit provides information on any derogation to the remuneration policy applied in exceptional circumstances within Section II Remuneration Report, in the following year.

## 2.3 Role of the Corporate Control Functions

### 2.3.1 Role of the Compliance Function

The Compliance function, operates in close coordination with the Human Capital function, in order to support the design and the definition of compensation policy and processes and to evaluate them from a compliance standpoint.

In particular, the Compliance function, through its structures, evaluates, in coherence with the goal to be compliant to regulations, the Group Remuneration Policy and the incentive systems for Group personnel as drawn up by Human Capital function. It provides input for the design - by Human Capital functions - of compliant incentive systems, as far as it is concerned.

The Group Incentive System for Material Group Risk Takers is defined by Group Human Capital function, with the involvement and collaboration of Group Risk Management and Finance functions, for the overall qualitative assessment of economic sustainability and of risk and Compliance function. This is to ensure consistency with the goal of complying with regulations, articles of association and any other code of ethics or other standards of conduct applicable to the bank, so that legal and reputational risks mostly embedded in the relationship with customers are duly contained (ref. Bank of Italy).

The Compliance function is also involved in the assessment process for the definition of the Material Risk Taker population, for all compliance-related aspects.

In accordance with the regulatory framework and the UniCredit governance, the guidelines for the definition of the incentive systems for non-Material Risk Taker population are arranged by Group Human Capital function, in collaboration with Group Compliance function.

At local level, the Human Capital structures define the detailed features of incentive systems and submit them to the reference Compliance structures.

### 2.3.2 Role of the Risk Management Function

UniCredit ensures the alignment between remuneration and risk through policies that support risk management, rigorous governance processes based on informed decisions taken by corporate bodies and the definition of compensation plans that include the strategic risk appetite defined by the Risk Appetite Framework, the time horizon and individual behaviors.

The Risk Management function is constantly involved in the definition of the remuneration policy, incentive system and compensation processes, in the identification of objectives, for the performance appraisal as well as for the assessment process to define the Group Material Risk Taker population. This involvement implies explicit link between the Group incentive mechanisms, selected metrics of the Risk-Appetite Framework, the validation of performance and pay, so that incentives are linked to the risk taking and management.

### 2.3.3 Role of the Internal Audit Function

As part of the remuneration system governance process, the Internal Audit function assesses the implementation of remuneration policies and practices, performing checks on data and internal procedures, in line with its internal policies and procedures. The function evaluates the compensation process, providing recommendations aimed at improving it and bringing to the attention of the relevant functions and bodies any potential weakness, for the adoption of appropriate corrective measures.

## 2.4 Material Risk Takers identification process

### 2.4.1 Process

Starting from 2010, UniCredit has regularly conducted a self-evaluation to define the Group Material Risk Takers population to whom, according to internal/external regulations, specific criteria for remuneration and incentive requirements are adopted.

Since 2014, UniCredit Group has a Material Risk Takers identification process following the Commission Delegated Regulation (EU) 604/2014. Since 2019, as foreseen by Bank of Italy Circular 285, Material Risk Takers identification process is an integral part of the Group Remuneration Policy and Report. Starting from 2021,

then consolidated at Group level, applying similar criteria that are assessed against the Group risk profile, as foreseen by the regulatory requirements.

### 2.4.3 Preliminary results of the identification process

The 2021 Material Risk Taker population was updated at the beginning of the year based on preliminary application of the new regulatory framework.

In January 2021, the preliminary result of the assessment process to define the Group Material Risk Taker (GMRT) population was broadly in line with the one of last year.

Amongst the total of GMRT belonging to the Business Functions, for whom the adoption of a maximum ratio between variable and fixed remuneration of 2:1 can be applied, it is highlighted that the expected number of GMRT with variable remuneration exceeding the 1:1 ratio is about 100.

In line with EBA and Bank of Italy provisions, UniCredit or the Group Legal Entities will evaluate the possibility to activate, in case of no material impact on Group/institution risks, the exclusion process, as per the foreseen regulatory timeline.

accountable to the management body, for the day-to-day management of the institution);

- staff members with managerial responsibility over the institution's control functions (Internal Audit, Risk Management, Compliance and other functions as locally defined) or material business units or for specific topics (e.g. accounting policies, finance, human resources);
- staff members with managerial responsibilities for specific risk categories, including voting members within relevant Committees, credit risk exposures, authority on certain transactions and authority on the introduction of new products;

- quantitative:
  - staff members entitled to significant total remuneration equal to or greater than EUR 500,000 and equal to or greater than the average remuneration awarded to the members of the institution's management body and senior management, having a significant impact on the MBU's risk profile (i.e. when Credit, Market or Operational RWA proxy is equal or above the 2% of the institution's Group);
  - staff member has been awarded in the preceding financial year a total remuneration that is equal to or greater than EUR 750,000;

- staff member is within the 0.3% of staff who have been awarded the highest total remuneration in the preceding financial year within an institution with over 1,000 members of staff (for individual identification purposes at Legal Entity level only);

- internal:
  - all Group personnel with "Senior Vice President" & above banding as defined in the Global Job Model (the role clustering system adopted by the Group);
  - all personnel awarded in the previous year a Total remuneration higher than Group defined threshold<sup>4</sup>;
  - all staff receiving UniCredit shares from Non Standard Compensation awards;
  - all incumbent with any other additional criteria linked to managerial decision, to be supported by rationale.

The Material Risk Taker identification process is performed at Legal Entity level using the above qualitative, quantitative and internal criteria assessed against the institution's individual risk profile and

that some individuals identified under quantitative criteria could not be considered as Material Risk Takers, activates the process for exclusion, involving, where requested, competent authorities.

In particular, UniCredit transmits to the European Central Bank or the Bank of Italy timely, and in any case within six months of the closing of the previous financial year, the request for authorization for personnel with total remuneration amount equal or higher than 750,000 Euro or within the 0.3% of the personnel which was awarded the highest total remuneration in the previous financial year.

Furthermore, the institution informs the European Central Bank or the Bank of Italy in case personnel with total remuneration amount equal or higher than EUR 500,000 and lower than 750,000 Euro have no material impact on Material Business Units (the notification is no more requested).

The identified personnel within the Material Risk Takers perimeter are informed through individual written notice.

Human Capital, Risk Management and Compliance repeat the process of evaluation throughout the year with the goal to update the list of Material Risk Takers based on specific events occurring during the year (e.g. appointment, hiring, organizational changes and any other relevant event), ensuring the process is performed continuously and that the re-evaluation of the Material Risk Takers perimeter is submitted to the Group Board of Directors, after being discussed in the Group Internal Controls and Risks Committee and in the Group Remuneration Committee.

### 2.4.2 Criteria

CRD V and EBA RTS set the regulatory standards concerning qualitative and quantitative criteria to identify categories of staff whose professional activities have a material impact on an institution's risk profile (so called Material Risk Takers). The identification process is based on the Material Business Unit (MBU) definition that, for consolidation purposes at Group level, is calculated as:

- any Legal Entity/ Division with an allocated Group Internal Capital equal or greater than 2%;
- organizational units within a Legal Entity with an allocated capital based on proxies equal or greater than 2% at Group level;
- core business lines.

Additionally, criteria (here below simplified) are distinguished in:

- qualitative:
  - all members of the management body and senior management (i.e. those who exercise executive functions within an institution and who are responsible, and

UniCredit adopts the identification process embedded in CRD V and in the new EBA RTS regulatory provisions.

The Material Risk Takers identification process is performed annually, on an ongoing basis, at both local and Group level, and also considers Agents involved in financial activities, Insurance Agents and Financial Advisors.

This Policy regulates the Material Risk Takers identification process and defines the roles and responsibilities of involved functions. In particular:

- Human Capital leads the identification process defining a consistent approach at Group level through specific guidelines;
- Risk Management leads the identification process of positions with material impact on an institution's risk profile of a material business unit;
- Compliance verifies the proper application of what is envisaged by Regulatory Technical Standards, Group Material Risk Takers Internal Guidelines and specific regulation.

Group Legal Entities are actively involved in the identification process of Material Risk Takers coordinated by UniCredit SpA, sharing with the Holding Company all necessary information as per received indications.

Specifically, the Group Legal Entities are obliged to identify Material Risk Takers on an individual basis, in compliance with the local or sector-specific regulations, and will adopt the same Group criteria applied at local level following operational and interpretative guidelines issued by the Group, which assures the overall consistency of the identification process Group wide. In any event, each Legal Entity is responsible to be compliant with the provisions directly applicable to them.

The Holding Company, considering the outcomes of the evaluation performed by the various entities as specified above, consolidates results with the goal to identify Group Material Risk Takers.

Subsequently, Group Human Capital together with Group Risk Management, after data consolidation and harmonization, presents documentation to the Group Internal Controls and Risks Committee and to the Remuneration Committee for discussion and finally submits for approval to the Group Board of Directors.

- the methodology<sup>4</sup> and evaluation process for Material Risk Takers both at Group and local level;
- the outcomes of the evaluation process;
- the possible exclusion of "high earners" from Group Material Risk Takers.

Indeed, at the end of the evaluation process, if UniCredit determines

4. To be presented by end of June 2021 to UniCredit SpA Internal Controls, Risks Committee, Remuneration Committee and Board of Directors.

5. The staff member is within the 0.3% of the holding Company staff awarded the highest total remuneration in the preceding financial year within the institution.

## 2.5 Compensation to Directors, Statutory Auditors and Executives with Strategic Responsibilities

The remuneration for members of the administrative and auditing bodies of UniCredit is represented only by a fixed component, determined on the basis of the relevance of the position and the time required for the performance of the responsibilities assigned. This policy applies to non-Executive Directors as well as to Statutory Auditors. The compensation paid to non-Executive Directors and Statutory Auditors is not linked to the economic results achieved by UniCredit and they do not take part in any incentive plans based on stock options or generally based on financial instruments. The remuneration policy for members of the corporate bodies of the Group Legal Entities is based on the same principles, consistently with the local regulatory requirements.

### Board of Directors

In accordance with UniCredit's Articles of Association, the outgoing Board of Directors presented its list of candidates for the renewal of this Body at the Shareholders' Meeting called for April 15, 2021, together with a proposal on the remuneration of the new Board of Directors and its Committees.

During the end of 2020 and the beginning of 2021, the Group Human Capital and Group Corporate Affairs functions supported the Remuneration Committee and more generally the Board of Directors in the formulation of a proposal to revise the remuneration for the new Board of Directors to be submitted to the Shareholders' Meeting of April 15, 2021, including attendance fees for participation in meetings of the Board and its Committees.

In formulating the proposal for the remuneration of the members of the Administrative Body, the following elements were considered, among others:

- the reduction of the number of Directors;
- market benchmark data - provided by a leading independent consultant, Willis Towers Watson - relating to the remuneration of members of the Board of Directors and Board Committees in the so-called "peer group" and in the major financial services companies in the FTSE MIB;
- the commitment required in relation to the activities of the individual Committees, in terms of time commitment (average duration of meetings) and scope of activities.

### Board of Statutory Auditors

Pursuant to Clause 30 of the Company's Articles of Association, the Ordinary Shareholders' Meeting is required to appoint five permanent Auditors, amongst whom the Chairman, and four substitute Auditors, ensuring the balance of genders. The appointed Auditors remain in office for three financial years with the relative term expiring on the date of the Shareholders' Meeting called to

approve the financial statements for the third financial year of their office.

Contextually, in addition to the appointment, the Shareholders' Meeting is called to resolve also on the annual remuneration due to the permanent members of the Board of Statutory Auditors for the entire term of office. No remuneration review is foreseen for 2021.

### CEO and Executives with Strategic Responsibilities

The Board of Directors also identifies the "Executives with Strategic Responsibilities" with own resolution, for the application of all related corporate and regulatory laws.

At the beginning of 2021, the group of Executives with Strategic Responsibilities is composed as follows: Group CEO, co-CEOs Commercial Banking Western Europe, co-CEOs Commercial Banking Central Eastern Europe, Head of Finance & Controls, Group Chief Risk Officer, Head of Group Human Capital, Chief Compliance Officer, Head of Group Legal, co-Chief Operating Officers (one of which also General Manager *Interim*) and Head of Internal Audit.

In line with the 2021 Group Remuneration Policy, the CEO remuneration framework is based on a fixed compensation defined between market median and upper quartile of the UniCredit EU peer group.

The CEO position, in line with the May 13, 2014 AGM decision, has a maximum variable remuneration of 200% of fixed compensation. In order to foster the alignment of the interests between the designated CEO and the shareholders, already in the first year in the role, the Board of Directors has approved a share-based award, representing the full variable remuneration for 2021, payable in two tranches, not subject to performance conditions, malus or claw-back, while subject to minimum prudential requirements at the time of payment, therefore allowing him to be compliant with the Group share ownership guidelines.

The proposed remuneration structure for 2021 is strictly linked to the first year of the mandate. For 2022 onwards a mix of performance based long-term and short-term incentives will be applied to the CEO.

The remuneration package does not include any remuneration aimed at compensating Mr. Ornel for the possible reduction or cancellation of remunerations deriving from previous employments (so called "buy out" as regulated under Circular 285/13 of Bank of Italy).

In order to ensure full managerial continuity, the Board of Directors appointed Mr. Raniero de Marchis as General Manager *Interim* of UniCredit SpA. Mr. de Marchis will remain General Manager until the

appointment of the new CEO. For the General Manager, the Board of Directors has defined a role based allowance on top of his current remuneration package linked to the Co-Chief Operating Officer role he is maintaining.

Based on the incentive systems in place, for the Executives with Strategic Responsibilities the 2021 reference pay-mix considering the maximum achievement of variable remuneration is represented in the following summary.

### 2021 reference pay-mix for the Executives with Strategic Responsibilities



Note based on the data in case of new appointments, non-standard compensation could be assigned with the max variable to fixed cap.  
 A. For CEO Share-based award for 2021, for Business Function and Others: 50% Long Term Incentive Remaining plus Short Term Incentive for Corporate Control Functions. Short Term Incentive only.  
 B. For Human Capital function the fixed remuneration is expected to be predominant in respect to the variable one and long-term variable remuneration is not foreseen.



## FOCUS

The members of the administrative and control bodies as well as the Executives with Strategic Responsibilities benefit from a specific civil liability insurance policy, the "Directors & Officers Policy", also known as D&O Policy. For the Directors and the Statutory Auditors, this benefit is approved by the Shareholders' Meeting.

The Chairman of the Board of Directors is entitled to life and permanent disability insurance coverage resulting from injury occurring under any circumstances.

The Directors, Statutory Auditors and the Secretary of the Board of Directors benefit from life and permanent disability insurance coverage arising from accidents that occurred while performing the specific duties of the position.

The Executives with Strategic Responsibilities benefit from the company treatment, provided for the Dirigenti population, relating to health care and life and permanent disability cover, in line with the band to which they belong under the Global Job Model.

Any benefits provided on an "ad personam" basis shall be managed in compliance with applicable regulations.

# 3. Compliance and Sustainability Drivers

To support the design of remuneration and incentive systems<sup>6</sup>, with particular reference to network roles (also including credit intermediaries) and Corporate Control Functions, the following "compliance and sustainability drivers" have been defined, in line with the applicable regulation<sup>7</sup>:

## ➤ Remuneration general principles

- Maintain an adequate balance of fixed and variable compensation elements also with due regard to the role and the nature of the business performed. The fixed portion is maintained sufficiently high in order to allow the variable part to decrease, and in some extreme cases to drop down to zero;
- set an appropriate mix between short and long-term variable compensation, consistent with the strategies, market and business practices of reference and in line with the long-term interests of the Group;
- foresee that the remuneration policy, with specific reference to variable remuneration, should contribute to the business strategy, long-term interests and sustainability of the company and should not be linked entirely or mainly to short-term objectives;
- include in the remuneration policies information on how those policies are consistent with the integration of sustainability risks.

## ➤ Incentive Systems

- Build incentive systems based on profitability, financial stability, sustainability and other drivers of sustainable business practice with particular reference to risk, cost of capital and efficiency;
- design flexible incentive systems so to manage payout levels in consideration of overall Group, country/division performance results and individual achievements, adopting a meritocratic approach to selective performance-based reward;
- design incentive systems which do not, in any way, induce risk-taking behaviors in excess of the Group's strategic risk appetite; in particular the incentive systems should be coherent to the Risk Appetite Framework ("RAF");
- design forward-looking incentive plans which balance internal key value driver achievements with external measures of value creation relative to the market;
- design incentive systems to set minimum performance thresholds below which zero bonus will be paid. In order to maintain the

adequate independence levels for Corporate Control Functions, for Human Resources and the Manager in Charge of Drafting the Company Financial Reports, provide a maximum threshold for the progressive reduction of the bonus pool, which can be phased out to zero only in presence of exceptionally negative situations with an approval process including a governance step by the Board of Directors;

- subject the remuneration to correction mechanisms that allow it to be reduced (even significantly) or zeroed, for example in the case of behaviors, by relevant persons or credit intermediaries, that have caused or contributed to significant damage to customers or a significant breach of the rules contained in Title VI of the TUF<sup>8</sup>, the relevant implementing provisions or Codes of Ethics or Conduct for the protection of customers applicable to the intermediary.

## ➤ Goals and performance management

- Maintain an adequate mix of economic and non-economic (quantitative and qualitative) goals, depending on the role, considering also other performance measures as appropriate, for example risk management, adherence to Group values or other behaviors;
- accompany the qualitative measures by an ex-ante indication of objective parameters to be considered in the evaluation, the descriptions of expected performance and the person in charge for the evaluation;
- relate the non-economic quantitative measures to an area for which the employee perceives a direct link between her/his performance and the trend of the indicator;
- include among the non-economic goals (quantitative and qualitative), where relevant, goals related to customer loyalty and level of satisfaction, risk as well as to compliance (e.g. credit quality, operational risks, application of MiFID principles, products sales quality, respect of the customer, Anti Money Laundering requirements fulfillment);
- set and communicate ex-ante clear and pre-defined parameters as drivers of individual performance;
- avoid incentives with excessively short timeframes (e.g. less than three months);
- promote a customer-centric approach which places customer needs and satisfaction at the forefront and which will not constitute an incentive to sell unsuitable products to clients;

6. Also considering third party incentives.  
7. Including also the provisions on transparency of banking and financial transactions and services, fairness of relations between intermediaries and clients.  
8. Title VI of the credit intermediaries act, transparency of contractual conditions and relations with clients.

- consider claw-back actions as legally enforceable on any performance-based incentive paid out on the basis of a pretext subsequently proven to be erroneous;
- include clauses for zero bonus in circumstances of non-compliant behavior or qualified disciplinary action, subjecting payout to the absence of any proceeding undertaken by the company for irregular activities or misconduct of the employee with particular reference to risk underwriting, sales processes of banking and financial products and services, internal code of conduct or values breach
- require employees to undertake not to use personal hedging strategies or remuneration and liability - related insurance to undermine the risk alignment effects embedded in their remuneration arrangements.

### Drivers for Commercial Campaigns and for Infra year bonus

Within network roles incentive systems, particular attention is paid to "Commercial Campaigns" and "Infra year bonus", which may be organized after receiving an opinion on the admissibility from the competent Committee (e.g. Product Committee). They represent business actions aimed at providing guidance to the sales network towards the achievement of the period's commercial targets (also intermediate for instance on a half-year basis) and with a direct impact on the budget and related incentive systems.

- Among the distinctive features of the commercial campaigns and of the infra year bonus, there is the expectation of the award - in cash or non-monetary reward. Commercial Campaigns and Infra year bonus can also help the function to accelerate the achievement of certain objectives of the incentive system. The grant of awards must be subordinated to behaviors compliant with the external and internal regulations.
- Under no circumstances may the system of remuneration and evaluation of the sales network employees constitute an incentive to sell products unsuitable to the financial needs of the clients. In particular, the following "compliance and sustainability drivers" have been defined:
  - set-up of the incentive mechanisms using criteria which are consistent with the best interest of the client, and which avoid

The remuneration policies drawn up in accordance with the Transparency regulation<sup>9</sup> include an indication of the number of relevant persons and credit intermediaries to whom they apply, as well as the role and functions held by them.

The indication of the role and functions of relevant persons is provided by area of activity, without prejudice to the distinction between persons who offer products directly to customers and persons to whom they report hierarchically.

13. Bank of Italy "The opacity of banking and financial transactions and services - Fairness of relations between intermediaries and clients."

- take into account, even in remuneration systems of the external networks (financial advisors), the principles of fairness in relation with customers, management of legal and reputational risks, protection and loyalty of customers, compliance with the provisions of law, regulatory requirements, and applicable self-regulations;
- create incentives that are appropriate in avoiding potential conflicts of interest with customers and in terms of market manipulation, considering fairness in dealing with customers and the endorsement of appropriate business conduct and usage of privileged information (e.g. benchmark contributors);
- consider performance on the basis of annual achievements and their impact over time;
- include elements which reflect the impact of individual's/business units' return on the overall value of related business groups and organization as a whole;
- avoid bonuses linked to economic results for Corporate Control Functions<sup>10</sup> for Human Resources and Manager in Charge of Drafting the Company Financial Reports and set, for the employees in these functions, individual goals that shall reflect primarily the performance of their own function and that will be independent of the results of monitored areas, in order to avoid conflict of interest;
- recommend the approach for Corporate Control Functions also where possible conflicts may arise due to the function's activities. In particular, this is the case of functions (if any) performing only control activities pursuant to internal/external regulations such as in some structures in Accounting/Tax structures<sup>11</sup>;
- ensure independence between front and back office functions in order to guarantee the effectiveness of cross-checks and avoid conflict of interest, with a particular focus on trading activities, as well as ensuring the appropriate independence levels for the functions performing control activities;
- define incentives that are not only based on financial parameters for personnel providing investment services and activities, taking into account the qualitative aspects of the performance; this in order to avoid potential conflicts of interest in the relationship with customers<sup>12</sup>;
- avoid incentives on a single product or financial instrument or specific categories of financial instruments, as well as single banking/insurance product;
- avoid an incentive for the joint selling of the optional contract and the financing as opposed to the sale of the financing alone, where the contract offered in conjunction with the financing is optional;
- promote prudent credit growth and appropriate risk-taking behavior, and not encourage excessive risk taking; variable remuneration of the staff involved in credit granting;

- is linked, among others, to the long-term quality of credit exposures;
- includes, in terms of performance objectives and targets, credit quality metrics and is in line with credit risk appetite;
- define, for Commercial Network Roles, goals that include drivers on quality/sustainability of the products sold, in line with client risk profile. Particular attention shall be paid to the provision of non-economic goals for customer facing roles selling products covered by MiFID. For these employees, the incentives must be defined in a way to prioritize customer loyalty and satisfaction and at the same time avoid potential conflicts of interest towards them;
- foresee, for the staff responsible for handling complaints, indicators taking into account, among other things, the results achieved in handling complaints and the quality of customer relations;
- indicate clearly within all rewarding system communication and reporting phases that the final evaluation of the employee achievements will also rely, according to local requirements on qualitative criteria such as the adherence to compliance and Code of conduct principles;
- put in writing, document and make available for the scrutiny of independent checks and controls the entire evaluation process;
- define ex-ante the evaluation parameters for those cases where individual performance evaluation systems are fully or partially focused on a managerial discretionary approach. These parameters should be predetermined, clear and documented to the manager in due time for the evaluation period. Such parameters should reflect all applicable regulation requirements<sup>13</sup> (including the balance between quantitative and qualitative parameters). The results of managerial discretionary evaluation should be formalized for the adequate and predefined monitoring process by the proper functions and an appropriate repository should be created and maintained (e.g. inspections/request from the Authorities);
- do not link goals, for research management and analysts, to any financial transactions or revenues of single business areas, but for example consider linking them to the quality and accuracy of their reports.

### ► Payout

- Defer performance-based incentive payout, as foreseen by regulatory requirements, to coincide with the risk timeframe of such performance by subjecting the payout of any deferred component until actual sustainable performance has been demonstrated and maintained over the deferral timeframe, so that the variable remuneration takes into account the time trend of the risks assumed by the bank (i.e. malus mechanisms);

9. Meaning Internal Audit, Risk Management and Compliance functions, pursuant to Bank of Italy Circular 285 of December 17, 2013, 29<sup>th</sup> update of October 23, 2018. Where it is clear both Underwriting and Risk Management functions, goals assignment must represent a source of conflict of interest between Risk Management and Underwriting activities.  
10. Where it is clear that the Underwriting, Sales and Investment functions are not performing a source of conflict of interest between Risk Management and Underwriting activities.  
11. As for example ESMA requirements, with reference to MiFID remuneration policies and practices, Technical Advice ESMA on MiFID II Final Report 2014-21544, MiFID II specific articles regarding remuneration incentives for relevant subjects.  
12. Also aligned with the guidance already provided in the previous notes.

# 4. Compensation Framework

compensation elements, consistent with market trends and internal analysis performed.

Moreover, the Board of Directors annually approves the criteria and the features of the incentive plans for Material Risk Takers, ensuring the appropriate balance of variable reward opportunities within the pay-mix structure.

Remuneration can be either:

- fixed (e.g. salary) or
- variable (e.g. short-term incentives, long-term incentives).

Within this section details are provided also with regards to the following topics:

- Continuous Monitoring of Market Trends and Practices;
- Ratio between variable and fixed compensation;
- Share ownership guidelines.

Additionally, according to their peculiarities, further remuneration components can be classified as fixed or variable remuneration as described in this chapter and in line with regulatory framework and more precisely:

- Non-standard compensation;
- Benefits;
- Severance.

Within the framework provided by the Group Remuneration Policy, UniCredit is committed to ensuring fair treatment in terms of compensation and benefits regardless of age, race, culture, gender, disability, sexual orientation, religion, political belief and marital status, as well as any other traits.

The total compensation approach of UniCredit provides for a balanced package of fixed and variable, monetary and non-monetary elements, each designed to impact, in a specific manner the motivation and retention of employees.

In line with the applicable regulations, particular attention is paid to avoid incentive elements in variable compensation which may induce behaviors not aligned with the company's sustainable business results and risk appetite.

As a policy target, Material Risk Takers total compensation is set on the market median as reference, with the possibility to increase (up to market upper quartile) to attract and retain top-class talents, able to improve UniCredit's competitive position, with individual positioning being defined on the basis of specific performance, potential and people strategy decisions, as well as UniCredit's performance over time.

With particular reference to the Material Risk Taker population, the Board of Directors, on the basis of the proposal made by the Remuneration Committee, establishes the compensation structure for top positions, defining the mix of fixed and variable

## 4.1 Continuous Monitoring of Market Trends and Practices

At Group level, UniCredit analyzes the overall compensation trends of the market through a continuous benchmarking activity, in order to make informed decisions and adopt competitive reward structures for effective retention and motivation of the key resources.

With specific reference to the Group Executive population, an independent external advisor supports the Remuneration Committee in the definition of the direct competitors that represent the international group-level peers of UniCredit (peer group) with regards to whom compensation benchmarking analysis is performed on market trends, practices and compensation levels.

The peer group is defined by the Remuneration Committee considering the main European competitors in terms of market

capitalization, total assets, business scope and dimension.

At country/division level and as appropriate throughout the organization, benchmarking and trends analysis may be conducted considering relevant peer groups to assure competitive alignment with the market of reference.

The peer group is subject to annual review to assure its market representativeness.

For 2021, the European peer group, is confirmed and considers: Banco Santander, Banque Populaire CE, Barclays, BNP Paribas, Commerzbank, Credit Agricole, Deutsche Bank, ING, Intesa Sanpaolo, NatWest Group, Nordea Bank, Société Générale, Standard Chartered and UBS.

Relevant persons and credit intermediaries to whom the rules on Banking Transparency apply

	Role/position covered	Subjects that offer products directly to customers	Subjects to which the former respond hierarchically
Employees	Senior Banker/Deputy Area Manager	450	175
	Branch Manager (including deputy, if any)	2,053	115
	Commercial Coordinator/Team Leader	254	209
	Private Banking/Wealth Management relationship manager	652	65
	Retail affluent relationship manager	2,426	1,883
	Retail mass market advisor	9,458	1,883
	Small business relationship manager	1,296	127
	Corporate banking relationship manager	886	81
	Product specialist	173	23
	Commercial assistants/staff	1,661	252
	Agent in financial activity	444	4
	Credit intermediary	19	1
	Other credit intermediaries	1	1
Financial Advisor	17	6	
Credit Intermediaries & Financial Advisors			

Data as of December 31, 2020.

## 4.2 Fixed compensation

### › Definition and objective

Fixed remuneration is the part of remuneration that is stable and irrevocable, determined and given based on the pre-defined criteria and not discretionary, such as, in particular, the professional experience and responsibility level, that does not create an incentive to risk taking and does not depend on the bank's performance.

Base salary is appropriate in the specific market for the business in which an individual works and for the skills and competencies that the individual brings to the Group.

The relevance of fixed compensation weight is sufficient to reward the activity rendered even if the variable part of the remuneration package was not paid due to non-achievement of performance goals such as to reduce the risk of excessively risk-oriented behaviors, to discourage initiatives focused on short-term results and to allow a flexible bonus approach.

## 4.3 Variable compensation

### › Definition and objective

Variable compensation includes any payments that depend on revenues/other goals) or on other parameters. It includes discretionary pension benefits and mutually agreed payments between the bank and its personnel in case of early termination of the employment relationship or office (excluding the statutory deferred payments and the indemnity in lieu of notice), and the carried interests. Additionally, it is any other form of remuneration that does not specifically qualify as fixed remuneration.

Variable compensation aims to remunerate achievements by directly linking pay to performance outcomes in the short, medium and long-term. This is then risk adjusted. To strengthen the alignment of shareholders' interest and the interests of management and employees, performance measurement reflects the actual results of the Company overall, the business unit of reference and the meritocratic differentiation and selectivity.

### › Features

Adequate ranges and managerial flexibility in performance-based payouts are an inherent characteristic of well-managed, accountable

### › Features

Specific pay-mix guidelines for the weight of fixed versus variable compensation are defined with respect to each target employee population. With particular reference to the Group Executive population, the UniCredit Remuneration Committee establishes:

- the criteria and guidelines to perform market benchmarking analysis for each position in terms of compensation levels and pay-mix structure, including the definition of specific peer groups at Group, country/division level and the list of preferred external "executive compensation providers";
- the positioning of compensation, in line with relevant market's competitive levels, defining operational guidelines to perform single compensation reviews as necessary.

For Material Risk Takers, the payout is phased to coincide with an appropriate risk time horizon. The design features of incentive plans for Material Risk Takers are aligned with shareholder interests and long-term, firm-wide profitability, providing for an appropriate allocation of performance related incentives in cash and in shares, upfront and deferred.

Incentives remunerate the achievement of performance objectives, both quantitative and qualitative, by providing for a variable bonus payment. An appropriately balanced performance-based compensation element is encouraged for all employee categories, as a key driver of motivation and alignment with organizational goals and is set as a policy requirement for all business roles. The design features, including performance measures and pay mechanisms, avoid an excessive short-term focus by reflecting the principles of the policy, focusing on parameters linked to profitability and sound risk management, in order to guarantee sustainable performance in the medium and long term. In alignment with the overall mission, the characteristics of incentive systems also reflect the requirements of specialized businesses.

More information on the compliance and sustainability drivers related to the design of remuneration and incentive systems, with particular reference to network roles and Corporate Control Functions, are reported in the dedicated section.

With particular reference to trading roles and activities, organizational governance and processes as well as risk-management practices provide the structure for a compliant and sound approach, whereby

levels of risk assumed are defined and monitored centrally by the relevant Group functions. This structure reinforces the consistent remuneration approach which adopts performance measures based on profitability rather than revenues, risk-adjusted rather than non risk-adjusted, relative rather than absolute indicators.

### 4.3.1 Short-Term Remuneration

Short-term remuneration aims to attract, motivate and retain strategic resources and maintain full alignment with the latest national and international regulatory requirements and with best market practices.

Payout is based on a bonus pool approach providing for a comprehensive performance measurement at individual and at Group/country/division level. Reward is directly linked to performance, which is evaluated based on results achieved and on the alignment with the leadership model and values of UniCredit. Performance management for Group Material Risk Takers is managed according to central governance ensuring fair and coherent appraisal process across the organization, leveraging on a unique repository at Group level.

For Material Risk Takers, the payout is phased to coincide with an appropriate risk time horizon. The design features of incentive plans for Material Risk Takers are aligned with shareholder interests and long-term, firm-wide profitability, providing for an appropriate allocation of performance related incentives in cash and in shares, upfront and deferred.

The short-term remuneration for Group Material Risk Takers population is regulated under the Group Incentive System, as described in the Group Remuneration Policy.

Additionally, local incentive systems (e.g. commercial campaigns, incentive systems for local Material Risk Takers) may exist, following the

### FOCUS

Group common guidelines on the key elements of Executive contracts ensure alignment with regulatory requirements and also with the Internal Audit recommendations, in particular regarding contract elements with specific regulatory provisions, such as variable compensation and severance provisions.

## 4.4 Non-standard compensation

Non-standard compensation are those compensation elements considered as exceptions (e.g. welcome bonus\*, special award, retention bonus, Role-Based Allowance, stability pact and non-competition agreement).

principles included in this Policy, and described within local regulations. Each year, detailed information about our compensation governance, key figures and the features of Group incentive systems is fully disclosed in the Group Remuneration Policy.

### 4.3.2 Long-Term Remuneration

Long-term remuneration aims to strengthen the link between variable compensation and Company results and further align the interests of senior management and shareholders.

The long-term remuneration provides for:

- the allocation - subject to the achievement of specific performance conditions - for future incentives based on shares or other instruments reflecting the trend of the share;
- a performance period aligned with UniCredit strategic targets;
- performance conditions based on a comprehensive Scorecard including, for example, financial and sustainability targets plus an overarching Board assessment;
- multi-year deferral with the application of Zero factor conditions, which provides for minimum requirements related to profitability, liquidity and capital;
- the application of a holding period of the actual awards after the deferral period;
- awards subject to individual malus and claw-back conditions, as legally enforceable

Group guidelines provided for the eligibility to variable

compensation have to be mentioned in the Executive contracts.

Amounts related to variable pay and any technical details of payments (vehicles used, payment structure and time schedule) are included in separate communication and managed in strict adherence to governance and delegation of authority rules.

Such awards are limited only to specific situations, as appropriate, to hiring phases, launch of special projects, a achievement of extraordinary results, high risk of leaving for Group Executives and mission critical roles and positions covered in specific corporate functions.

14. For the retention of new staff and limited to the first year of employment, it cannot be granted more than once to the same person, either by the bank or by another legal entity in the group. Bank circular 285 of December 27, 2013, 2<sup>nd</sup> update of October 25, 2018.

variable and fixed remuneration, technical features defined by regulation for bonus payout, if applicable) and subject to UniCredit governance processes, periodically monitored and disclosed for regulatory requirements, as well as subject to capital and liquidity entry conditions, malus conditions and claw-back actions, as legally enforceable. Variable non-standard compensation rules are specified either on the dedicated letter of award or referring to the Group Incentive System rules in force.

**FOCUS**

**Role-Based Allowance**

In 2019, UniCredit introduced Role-Based Allowances (RBA) for Corporate Control Functions in Italy. RBAs are considered fixed components of the remuneration, in line with regulatory provisions and market practices.

This compensation item aims to:

- ensure competitiveness on international level in terms of total compensation, avoiding excessive increases in the base salary in consideration of restrictive variable to fixed ratio for Corporate Control Functions in Italy;
- allow and facilitate the rotation between business and control functions roles within the Group;
- provide a sign of attention to the professional figures who hold relevant roles for the Group.

RBA in UniCredit has the following features:

- it is targeted at specific roles, covering Corporate Control Functions' positions in Italy with Senior Vice President and above banding (ca. 40 executives);
- it is a pre-defined amount (depending on banding and not at individual level); this amount (yearly gross) equals to 20,000 Euro for SVP, 40,000 Euro for EVP and 60,000 Euro for SEVP; it can be re-evaluated every three years based on changes in the cost of living;
- it cannot be reduced, suspended or cancelled discretionally as long as the employee is in a specific role granting the allowance within a given banding level;
- it is not linked to performance and therefore does not favor risk-taking attitude

As a general rule, RBAs are individually assigned to the employee at the date of the appointment to a control function role, and removed in case of moves in positions not eligible for an RBA.

**4.5 Benefits**

**> Definition and objective**

Benefits include welfare benefits that are supplementary to social security plans, healthcare and work-life balance benefits and are intended to provide substantial guarantees for the well-being of staff and their family members during their active career as well as their retirement.

In addition, special terms and conditions of access to various banking products and other services may be offered to employees in order to support them during different stages of their lives.

From a total compensation perspective, benefits aim to reflect internal equity and overall coherence of the remuneration systems, meeting the needs of different categories as appropriate and relevant.

Benefits that are not awarded on the basis of the above common criteria are considered variable remuneration.

Furthermore, UniCredit affirms the value of share ownership as a valuable tool for enabling the engagement, affiliation and alignment of interests among shareholders, management and

**4.6 Severance**

According to the regulatory requirements included in the Bank of Italy Circular 285, a specific Policy on payments to be agreed in case of early termination of a contract (so called Severance Policy) was firstly submitted for approval to the 2015 Annual General Meeting.

An update of that policy, with more restrictive provisions compared to the previous one, was then approved by the 2017 Annual General Meeting.

On October 23, 2018, Bank of Italy had published the 28<sup>th</sup> update of the Circular 285 that, *inter alia*, ruled that all amounts defined upon or in view of the early termination of the employment - with the exception of the notice due by law and the statutory deferred pay (Trattamento Fine Rapporto) - are variable remuneration and are included in the calculation of the cap to the variable remuneration for the Material Risk Takers, with the exception of:

- the consideration for non-competition covenants that do not exceed one annual fixed remuneration for each year of duration of the undertaking;
- the amounts for the settlement of an existing or potential dispute related to the resolution of the employment, as long as calculated on the basis of a predefined formula contained in the Policy.

As a consequence, it had been submitted for approval to the Annual General Meeting of April 11, 2019, a further update of the Severance Policy that, without changing the main criteria and limits, incorporated the new regulatory requirements, foreseeing - *inter alia* - a predefined formula for the calculation of severance payments that, used for the settlement of a current or potential dispute related to employment termination, allows not to count them within the cap for the variable remuneration.

On April 15, 2021, a further update of the Policy is submitted to the Shareholders' Meeting for approval, aimed at reflecting changes in UniCredit's competitive positioning and managing specific compensation practices in particular situations.

In particular, the main amendment proposed envisages - without prejudice to all the main terms of the current Policy<sup>45</sup> - that only the absolute maximum amount is increased from 7.2 million Euro to 15 million Euro in view of the new competitive positioning.

the overall employee population. The possibility is therefore considered, from time to time and as appropriate in light of local legal and tax requirements, to offer employees the opportunity to invest and participate in the future achievements of the Group through share-based plans whereby employees can purchase UniCredit shares at favorable conditions.

It is also proposed to specify that:

- in the case of multi-year incentive plans with lump sum disbursement, the reference remuneration for the calculation of severance pay will conventionally consider the disbursement as spread over the vesting/maintenance period;
- in the case of Dinigenti whose total remuneration is paid under various contracts that in any event represent the components of a single overall framework, the reference remuneration for the calculation of severance payments will be the total remuneration received under the various contracts, provided that these contracts are terminated at the same time.

For details on criteria, limits and authorization processes, please refer to the above-mentioned Policy.

Generally, the calculation of any severance payment takes into consideration the long-term performance in terms of shareholder added value, as well as any local legal requirements, collective/individual contractual provisions, and any individual circumstances, including the reason for termination.

According to the Severance Policy provisions confirmed in the review approved in 2019, severance payments, inclusive of notice, do not exceed 24 months of total compensation (including the base salary and the average amount of the incentives actually received during the last three years prior to the termination, after the application of malus and claw-back, if any). Further elements - such as the value of fringe benefits possibly granted to the employee - may be included in the computation of the above-mentioned basis if this is required or foreseen by regulations, laws, contracts or common practices locally applicable). It is also foreseen that the amount of the payments additional to notice cannot exceed 18 months of compensation. In any case, the termination payments, which consider also the duration of the employment, do not exceed the limits foreseen by the laws and collective labor agreements locally applicable in case of lay-off.

As a rule, discretionary pension benefits are not granted and, in any case, even if they might be provided in the context of local practices and/or, exceptionally, within individual agreements, they would be paid consistently with the specific and applicable laws and regulations.

15. In particular, that severance pay, including notice, shall not exceed 24 months of total remuneration, that the additional portion of notice shall, in no case exceed 18 months remuneration and that the absolute maximum limit of severance pay shall remain at 9 times the remuneration with no possibility of exceptions.

Individual contracts should not contain clauses envisaging the payment of indemnities, or the right to keep post-retirement benefits, in the event of resignations or dismissal/revocation without just cause or if the employment relationship is terminated following a public purchase offer. In case of early termination of the mandate, the ordinary law provisions would therefore apply.

#### 4.6.1 Members of the Board of Directors, General Managers and other Executives with Strategic Responsibilities

With particular reference to the members of the management bodies, general managers and other key management personnel and the related requirements set out by Consob issuers Regulation no. 11971, it is specified that:

- the treatments envisaged in the event of termination of office or termination of employment are set out in the "Group Termination Payments Policy", which, pursuant to Bank of Italy regulations, is subject to specific approval by the Shareholders Meeting;
- the members of the Board of Directors are bound by directorships, the term of which coincides with the term of office. In the event of early termination, the normal legal provisions shall apply to them.

General Managers and other Executives with Strategic Responsibilities have employment relationships, generally of indefinite duration, as Dirigenti under the "National Collective Labour Agreement for Managers employed by credit, financial and instrumental companies" (the "CCNL");

- the notice period foreseen for the termination of the relationship, if the circumstances foreseen by the law occur, is the one foreseen by the CCNL. In the event that agreements are in place that, at individual or aggregate level, envisage the recognition of conventional seniority and/or measures that differ from the standard ones, the circumstance is reported in the Remuneration Report.  
In no case the notice period exceeds 12 months;

- all the criteria for determining the amounts agreed between the bank and the staff in view of or on the occasion of the early termination of the employment relationship or for the early termination of the office are defined within the "Group Termination Payments Policy", which also provides indications of the components to be considered in the calculation of the reference remuneration and the elements to be used, within the framework of a specific formula, to determine the number of months' pay actually due;

- the amounts paid in relation to the termination of the relationship take into account, in any case, the long-term performance, the creation of value for shareholders, and do not reward failure or abuse. For further details in this regard, please refer to the "Group Termination Payments Policy";

- the regulations of the short-term and long-term incentive plans determine what effect termination of employment has on them, depending on the circumstances. In general, termination results in the loss of all benefits payable, except in specific circumstances where the individual qualifies as a "good leaver". In such cases, if the termination occurs during the performance period, the beneficiary will be entitled to a pro rata award of shares, subject to the achievement of the relevant conditions at the end of the period and, in any event, in accordance with the deferred payment schedule and all other terms and conditions set forth in the regulations.

Recognition of good leaver status is generally provided in the following cases:

- termination due to any physical impediment including illness, injury or permanent disability as determined by applicable laws;
- retirement, including by agreement with the Company and/or enrollment in early retirement or redundancy plans;
- the company that employs, or the line of business in which the beneficiary works, ceases to be part of the Group or is transferred to a person or legal entity not belonging to the Group.

The status of "good leaver" may also be acknowledged, taking into account the specific circumstances and the company's interest, within the scope of specific agreements entered into with the beneficiary upon - or in exceptional cases, before - termination of the relationship.

Any agreements that provide for ex-ante recognition of the status of "good leaver" as an exception to the principles outlined above are disclosed in the Remuneration Report;

- the granting or retention of non-monetary benefits beyond a short transitional period immediately following the termination of the relationship, or the conclusion of consultancy contracts for a period following the termination of the relationship, is generally excluded.  
Should this occur, the circumstance would be reported in the Remuneration Report and the economic benefit would be included in the provisions of the "Group Termination Payments Policy".

## 4.7 Ratio between variable and fixed compensation

In compliance with applicable regulations, it has not changed - for the personnel belonging to the business functions - the adoption of a maximum ratio between variable and fixed remuneration of 2:1 as approved by the Annual General Meeting of May 13, 2014.

Positions entitled to a variable to fixed ratio of potentially up to a maximum of 2:1 are:

- Group Chief Executive Officer;
- Group Heads and Deputies of Commercial Banking, Corporate and Investment Banking, Chief Operating Office function, Finance & Controls function;
- CEO and General Managers of Group Legal Entities;
- Personnel belonging to Business Divisions (e.g. Commercial Banking, Corporate and Investment Banking), excluding control or support roles.

Assumptions upon which the increase of the maximum ratio between variable and fixed remuneration, type of personnel and limit itself were based have not changed (e.g. UniCredit business model kept substantially stable since 2014, the compensation strategy is competitive at international level and basically in line with the one in 2014). Although UniCredit capital ratios satisfy all the applicable regulatory capital requirements with a substantial buffer, under the current circumstances due to the pandemic, ECB issued recommendations, applicable also to the Group, to restrict the distribution of dividends as well to moderate the variable remuneration. In particular, on December 15, 2020, ECB issued a letter reiterating its expectation that the institution will continue to adopt extreme moderation with regard to variable remuneration until September 30, 2021, especially for Material Risk Takers. These supervisory expectations are related to the current exceptional circumstances and will remain valid until the end of September 2021. At that time, in the absence of materially adverse developments, ECB intends to return to assessing banks' remuneration policies and practices in the context of the normal supervisory cycle.

Assuming this condition will occur, UniCredit has set its variable remuneration policy to respect in a forward-looking perspective the regulatory capital recommendations on variable remuneration issued before the pandemic outbreak<sup>16</sup>.

In 2021, a preliminary estimation of Group Material Risk Takers belonging to this category, which however exceed the 1:1 limit are ca. 100 staff members.

The estimated portion of the 2021 Incentive System that could be awarded to those roles in excess to the 1:1 ratio is less than 8% of the overall estimated pool (approx. € 12 million, of which € 6 million in UniCredit shares), with a potential impact on UniCredit share capital of approximately 0.06%, assuming that all free shares for employees are distributed. This amount of capital (i.e. €12 million) is equivalent to ca. 0.4 bps of UniCredit Group CET1 ratio.

In light of this information, it is set that the decision to maintain a maximum level of variable remuneration of 2:1 of the fixed remuneration for the personnel belonging to the business functions (as approved by the Annual General Meeting on 2014) would not affect the Group maintenance of a sound capital base.

Therefore, the adoption of a ratio of 2:1 between variable and fixed compensation does not have any implications on the bank's capability to continue to respect all prudential rules, in particular capital requirements.

This approach allows UniCredit to maintain a strong link between pay and performance, as well as competitiveness in the market. Our main peers have also taken the same approach in order to limit the effects of the un-even playing field in the market, where the cap is not present, to avoid the rigidity of the cost structure derived from a possible increase of fixed costs and to guarantee the alignment with multi-year performance, through deferring a relevant component of the variable compensation.

For the rest of the staff a maximum ratio between the components of remuneration equal to 1:1 is usually adopted, except for the staff of the Corporate Control Functions, for Human Resources and the Manager in Charge of Drafting the Company Financial Reports for which it is expected that fixed remuneration is a predominant component of total remuneration. For these functions is also foreseen that incentive mechanisms are consistent with the assigned tasks, as well as being independent of results from areas under their control.

For the Corporate Control Functions, in particular, the maximum weight of the variable component will take into account the differences between national rules and regulations in application of Directive 2019/878/EU in the various countries in which the Group operates<sup>17</sup>, in order to ensure equal operating conditions in the market and the ability to attract and retain individuals with professional skills and capabilities adequate to meet the needs of the Group.

16. ECB letter - Variable remuneration policy of UniCredit SpA, as of January 2020.

17. In particular, for the national regulatory corporate control functions in Italy, the ratio between the variable and the fixed components of remuneration cannot exceed the limit of one third as per Banki Prodotto (Circular of December 17, 2011, 25<sup>th</sup> update of October 25, 2018).

# 5. Group Compensation Systems

## 5.1 2021 Group Incentive System

- In line with past years, the 2021 Group Incentive System, as approved by UniCredit Board of Directors on January 13, 2021, is based on a bonus pool approach which is compliant with the most recent national and international regulatory requirements and links bonuses with company results at Group and country/division level, ensuring a strong connection between profitability, risk and reward. In particular, the system provides for:
  - the definition of eight bonus pools for each country/division, whose size depends on actual profitability;
  - allocation of a variable incentive defined on the basis of the determined bonus pool, individual performance evaluation, internal benchmark for specific roles/markets and maximum ratio between variable and fixed compensation as approved by the Annual General Meeting;
  - a malus condition (Zero Factor) which applies in case specific thresholds of profitability, capital and liquidity are not met at both Group and country/division level;
- risk adjusted metrics in order to guarantee long-term sustainability regarding company financial position and to ensure compliance with regulations;
- definition of a balanced structure of upfront (following the moment of performance evaluation) and deferred payments, in cash and/or shares for Group Material Risk Takers;
- distribution of share payments which take into account the applicable regulatory requirements regarding the application of share retention periods.

2021 Bonus pool Clusters	
Commercial Banking Italy	CEE
Commercial Banking Austria	CEO Functions
Commercial Banking Germany	CIB
HWB Subgroup	COO

The 2021 Incentive System is based on the following methodology:

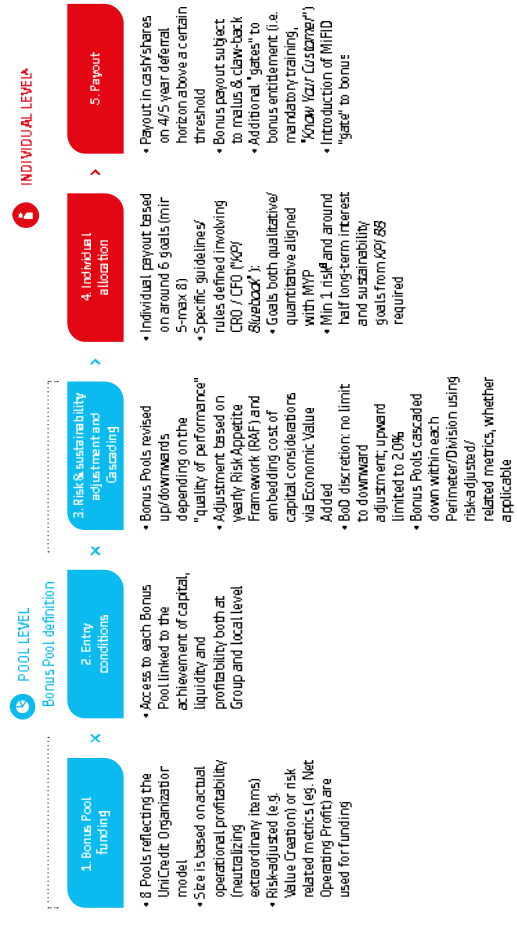

A. Rules for senior population principle apply to the rest of the organisation as well.  
B. Risk adjusted or risk related

request to approve, with a dedicated resolution, a higher maximum level of the ratio between the variable and fixed component of remuneration of up to 200% by the shareholders' General Meeting, in coherence with the approach defined by the Holding Company in terms of positions, and manage the related notification to the competent regulator, as appropriate.

## 4.8 Share ownership guidelines

The achievement of the share ownership levels should be accomplished through a pro-rata approach over a 5-year period, granting the minimum amount of shares each year, taking into consideration potential vested plans.

Involved Executives are also expected to refrain from activating schemes or arrangements that specifically protect the unvested value of equity granted under incentive plans (so called "hedging").

Such clauses are contained in all relevant incentive plan rules and apply to all beneficiaries, since involvement in such schemes undermines the purpose of limiting the risk. Any form of violation of share ownership guidelines as well as any form of hedging transaction shall be considered in breach of Group compliance policies with such consequences as provided for under enforceable rules, provisions and procedures.

Local adaptations based on specific regulations and/or business shall be envisaged consistently with the global approach at Group level.

Consistently with the framework described above, Group Legal Entities set in their remuneration policies the appropriate level of the maximum ratio between the variable and fixed compensation according to the national law, Group approach/Group Remuneration Policy, taking into account the business activities, the risks and the impact that different categories of staff have on the risk profile. Where allowed by the local law, the Legal Entities manage the

Share ownership guidelines set minimum levels for company share ownership by relevant Executives<sup>18</sup>, aiming to align managerial interests to those of shareholders by assuring appropriate levels of personal investment in UniCredit shares over time.

The ownership of UniCredit shares by Group leaders is a meaningful and visible way to show investors, clients and people the commitment towards UniCredit.

The Board of Directors approved at the end of 2011 the share ownership guidelines applied to the Chief Executive Officer, to General Manager and Deputy General Manager roles, if any, and on March 2017 extended the application to Senior Executive Vice President and Executive Vice President positions (see image below).

The established levels should be reached, as a rule, within five years from the appointment to the above indicated Executives categories within the scope of the guidelines and should be maintained until the role is held.

### Share ownership guidelines

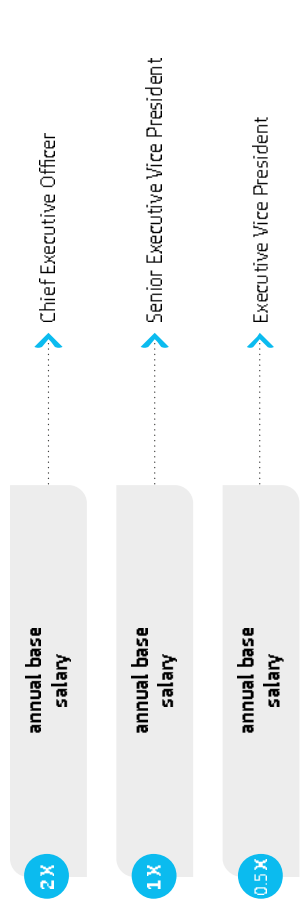

18. Considering the application from 2016 of the new ratio between variable and fixed components of remuneration (which cannot exceed the limit of one third of the variable risk-takers within the same Board Functions while fixed remuneration is expected to be the predominant component for the Board Functions of senior categories), share ownership guidelines are not applied to executives who are part of Corporate Control Functions.





5.1.4 Individual Allocation

For each Group Material Risk Taker a specific "Reference Value" is defined which considers the internal and/or external benchmarking analysis on similar roles, the seniority, the maximum ratio between variable and fixed compensation as approved by the Annual General Meeting. Such value is adjusted according to the actual available bonus pool and represents the starting point for the individual bonus allocation.

Individual bonus will be allocated managerially, considering the individual performance appraisal and the above mentioned Reference Value.

At individual level it will be also considered the respect of provisions of law, Group's compliance rules, Company policies or integrity values, Code of Conduct and the application of claw-back clauses, as legally enforceable.

Moreover, each participant has to complete the mandatory trainings courses and, for impacted roles, the customer due diligence periodic review (Know Your Customer) and the MIFD Customer Profiling within a pre-defined threshold in order to be entitled to the bonus.

Each Group Material Risk Taker receives the Group Incentive System Rules with a detailed description of the system and its application.

Individual performance appraisal is based on 2021 Scorecard: around six individual goals assigned during the performance year, selected from the catalogue of main key performance indicators (KPI/Bluebook) and inspired by the "Five Fundamentals"<sup>24</sup>.

In particular for the Group Material Risk Takers it is possible to include from five to eight goals with an adequate economic/non-economic mix, also in terms of number of objectives assigned and the weight given to each objective. The goals are mandatorily selected from the KPI/Bluebook with the possibility to assign up to two custom goals.

Competencies and behaviors considered as relevant are taken into account by the manager for the overall performance appraisal. Further details are reported in paragraph 5.2.

The performance appraisal system is based on a 5-point rating scale with a descriptive outcome and reflects the evaluation of the individual goals ("what") and of the behaviors acted to achieve them ("how").

2021 Performance Appraisal Scorecard

ILLUSTRATIVE

KPI/Perimeter	Target/ Performance Criteria	Risk Adjusted/ Related	Sustainable/ Long-Term Interest	Weight
<b>ECONOMIC GOALS</b>				
Goal 1	...	✓	✓	...%
Goal 2	...	✓		...%
Goal ...	...		✓	...%
<b>NON-ECONOMIC GOALS</b>				
Goal 1	...	✓		...%
Goal 2	...	✓	✓	...%
Goal ...	...		✓	...%

VALUES & BEHAVIORS



Qualitative assessment of adherence to 5 Fundamentals and Ethics & Respect values

OVERALL PERFORMANCE

5-point rating scale

In particular, based on Entry Conditions achievement, in case the CRO assessment reports the maximum positive result, accessibility has been confirmed from positive EVA values and the Board of Directors exercises the maximum discretion, the following scenarios may occur:

- if the Entry Conditions are not met only at Group level, the gate is "partially open", with the possibility to payout a reduced bonus value, except for the Group CEO and all the Senior Executive Vice Presidents, irrespective of country or area of activity;
- if the Entry Conditions are met both at Group and country/division level, the gate is "fully open", meaning the bonus pools may be fully confirmed or even increased (up to max. 144%<sup>22</sup>).

In any case as requested by Bank of Italy regulations, the final evaluation of Group sustainable performance parameters and the alignment between risk and remuneration will be assessed by the Remuneration Committee and defined under the governance and accountability of the Board of Directors.

The Board of Directors has the right to disregard, when deciding bonus, balance sheet extraordinary items which do not impact operational performance, regulatory capital and liquidity, therefore considering the Underlying Net Profit (the same metric used for capital distribution).

Example of bonus pool definition

ILLUSTRATIVE

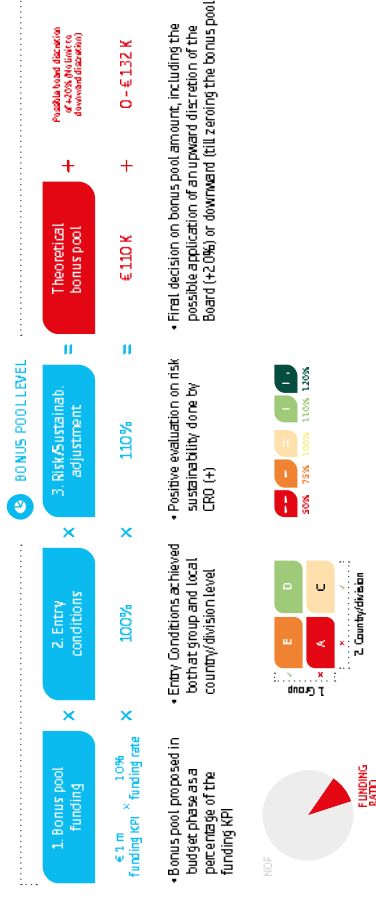

Once the bonus pools are approved by the Board of Directors, starts the breakdown process to cascade the pools within each perimeter/division starts. The breakdown process takes into account risk adjusted-related indicators that are assessed at year-end, where applicable according to business features (e.g. not for Operations). The year-end assessment takes into consideration the weighted average scoring of the single indicators.

Following potential changes in current regulations and/or in relation to potential extraordinary and/or unpredictable contingencies which can impact the Group, the company or the market in which it operates, the Board of Directors, having heard the opinion of the Remuneration Committee, maintains the right to amend the system and relevant rules, consistently with the overall setup approved by the Annual General Meeting and to that extent as it is functional to keeping the essential contents of the system substantially unchanged, preserving its main incentive purposes.

Moreover, in order to guarantee adequacy, fairness and internal consistency of the incentive system, in its particular provisions and among these as a whole, the mechanisms and instruments illustrated above must be interpreted as a single and inseparable whole, since the specific provisions envisaged herein may therefore be applied by analogy to further, similar and unregulated situations (or differently regulated), whenever the diversity of regulations would result in an objective inconsistency and unfairness of treatment.

22. Maximum scenario achieved in case of positive CRO assessment and being all the Board of Directors' discretion to approve a bonus pool: max. +20% of the theoretical one (€109K/120% CRO) (€109K ÷ 0.9K BOD discretion)

23. Maximum scenario achieved in case of positive CRO assessment and being all the Board of Directors' discretion to approve a bonus pool: max. +20% of the theoretical one (€109K/120% CRO) (€109K ÷ 0.9K BOD discretion)

24. The "Five Fundamentals" are the main pillars of UniCredit culture and are at the basis of the UniCredit Compliance Model that describes those behaviors that are expected from all UniCredit people and through which employees are assessed in performance management processes. The "Five Fundamentals" are: Customer First, Respect for Client, Integrity, Collaboration, Synergies, Risk Management, Decisions, Discipline.

Particular attention is dedicated to the level of correlation between proposed bonus and actual performance both at the bonus proposal step and consolidation phase.

**Compensation distribution guidelines**

Bonus vs Reference Value <sup>a</sup>	OVERALL PERFORMANCE				Outstanding
	Inadequate	Inconsistent	Solid	Strong	
> 130%					
110% - 130%					
80% - 110%					
0% - 80% <sup>b</sup>					
0%					

Note: Compensation distribution guidelines should take into account the max. variable deferred cap by role.

- A: Adjusted according to the actual available bonus pool.
- B: Bonus above standard proportion is allowed in exceptional cases, to be justified.

**5.1.5 Payout Structure**

As approved by the Board of Directors on January 13, 2021, with reference to payout structure, the Group Material Risk Taker population will be differentiated into four clusters, using a combined approach of position and compensation:

- for Senior Management<sup>25</sup> 5-year deferral schemes are applied, consisting in a payout structure of 6 years in total, a higher deferral percentage is applied in case of High Earners (variable remuneration > 430,000 Euro<sup>26</sup>);
- for other Material Risk Takers 4-year deferral schemes are applied, consisting in a payout structure of 5 years in total, a higher deferral percentage is applied in case of High Earners (variable remuneration > 430,000 Euro).

The payout of incentives will be done through upfront and deferred installments, in cash or in UniCredit ordinary shares, over a multi-year period.

All the installments are subject to the application of claw-back conditions, as legally enforceable.

**Deferral scheme**

	2021	2022	2023	2024	2025	2026	2027
Senior Management <sup>a</sup> with variable remuneration > € 430,000	performance year	20% upfront cash	20% upfront shares	12% deferred cash	12% deferred shares	12% deferred shares	12% deferred cash
Senior Management <sup>a</sup> with variable remuneration ≤ € 430,000	performance year	25% upfront cash	25% upfront shares	10% deferred cash	10% deferred shares	10% deferred shares	10% deferred cash
Other Material Risk Takers with variable remuneration > € 430,000	performance year	20% upfront cash	20% upfront shares	15% deferred shares	15% deferred shares	15% deferred cash	10% deferred shares
Other Material Risk Takers with variable remuneration ≤ € 430,000	performance year	30% upfront cash	30% upfront shares	10% deferred shares	10% deferred shares	10% deferred cash	10% deferred shares

Report view, also including retention period (set to upfront and deferred shares).

<sup>a</sup> Staff members which are Senior Management of the legal Entities of Group (EU as well as all Executive Vice Presidents in the Group legal Entities. This includes, regardless of the holding group CEO, Heads of Group Business Divisions (e.g. Commercial Banking, CB, CEB), Heads of Group Commercial Lines (e.g. Group Commerce, Group Insurance, etc.), Group CEO reporting lines and all other Senior Management roles in Group legal Entities (as defined by Bank of Italy) receiving a significant amount of variable remuneration.

At local level, Group Entities may perform calibrations on the length of the deferral schemes and/or the use of financial instruments to be aligned with more restrictive local regulations.

The number of shares to be allocated in the respective installments shall be defined in 2022, on the basis of the arithmetic mean of the official market price of UniCredit ordinary shares during the month preceding the Board of Directors to which the 2021 bonuses are submitted, after having evaluated performance achievements.

The Board of Directors assigns free UniCredit ordinary shares that will be freely transferable at the end of the retention period.

For Group Material Risk Takers, the annual variable remuneration has to be deferred if:

- is above 50,000 EUR or
- represents more than one third of the total annual remuneration.

Below this threshold no deferral mechanisms will be applied, according to relevant regulatory indications.

The maximum value of the 2021 Group Incentive System for the Group Material Risk Takers receiving UniCredit ordinary shares is approximately € 178 million, due to estimated slightly higher number of Material Risk Takers compared to previous year, with

an expected impact on UniCredit share capital of approximately 0.92%, assuming that all free shares for employees are distributed. Out of this amount, the estimated portion that could be awarded to business functions roles, exceeding the 1:1 ratio between variable and fixed remuneration, is less than 8% of the overall pool (approx. € 12 million distributed on approx. 100 beneficiaries), with a potential impact on UniCredit share capital of approximately less than 0.06%, assuming that all free shares for employees are distributed.

The overall dilution for all other current outstanding Group equity-based plans equals 2.50%.

The beneficiaries cannot activate programs or agreements that specifically protect the value of unavailable financial instruments assigned within the incentive plans. Any form of coverage (hedging) will be considered a violation of compliance rules and imply the consequences set out in the regulations, rules and procedures.

With the goal to respect this provision, Corporate Control Functions perform sample checks on custody and administration internal accounts for Material Risk Takers and require them to communicate the existence towards other intermediaries of custody and administration accounts and their performed transactions and financial investments, if any.

<sup>25</sup> Staff members which are Senior Management of the legal Entities of Group (EU as well as all Executive Vice Presidents in the Group legal Entities. This includes, regardless of the holding group CEO, Heads of Group Business Divisions (e.g. Commercial Banking, CB, CEB), Heads of Group Commercial Lines (e.g. Group Commerce, Group Insurance, etc.), Group CEO reporting lines and all other Senior Management roles in Group legal Entities (as defined by Bank of Italy) receiving a significant amount of variable remuneration.

<sup>26</sup> 450,000 Euro is the lower amount between 10 times the average fixed total compensation and the 25% annual compensation of total fixed remuneration as reported by CEO, as defined in 2018.

<sup>27</sup> Considering also the share of any material financial findings (e.g. Audit Bank of Italy, Control and/or any good local authority).

- retirement, also in case of agreement with the Company and/or enrollment into early retirement or redundancy plans;
- the company employing the Employee ceasing to be a member of the Group;
- a transfer of the undertaking, or the part of the undertaking, in which the Employee works to a person or legal entity which is not a member of the Group.

The status of "Good Leaver" may also be granted, taking into account the specific circumstances and the company's interest, within the scope of specific agreements entered into with the beneficiary.

- termination of the employment relationship due to any physical impediment including ill-health, injury or permanent disability, as established by applicable laws;

**FOCUS**

**Compliance breach, Malus and Claw-back**

The Group reserves the right to activate malus and claw-back mechanisms, namely the reduction/cancellation and the return respectively of any form of variable compensation.

The Group reserves the right to activate malus and claw-back mechanisms, namely the reduction/cancellation and the return respectively of any form of variable compensation.

In case of *ex-ante* risk adjustment, the Malus mechanism (the reduction/cancellation of all or part of the variable remuneration) can be activated to the variable remuneration to be awarded. In addition to the adjustment on the variable remuneration, promotion and merit salary reviews might as well be subject to the compliance breach assessment. In case of *ex-post* risk adjustment, the Malus mechanism (the reduction/ cancellation of all or part of the variable remuneration) can be applied to the deferred components that have already been awarded and have not yet been paid out, for the year in which the breach occurred. If the outstanding variable remuneration is not sufficiently large to ensure an appropriate malus mechanism, the reduction may be applied also to other variable remuneration components (e.g. deferred component from other years than the year in which the breach occurred or the variable remuneration awarded for the year and not yet paid).

Claw-back mechanism (the return of all or part of the variable remuneration) can be activated on the overall variable remuneration already paid, awarded for the time period during which the breach occurred, unless different provisions by local regulations or more restrictive provisions are in force.

The claw-back mechanisms can be activated up to a period of 5 years after the payment of each installment, also after the employee's contract termination and/or the end of the appointment and take into account legal, social contributions and fiscal profiles and the time limits prescribed by local regulations and applicable practices.

Malus and claw-back mechanisms may apply in the case of verification of behaviors adopted in the reference period (performance period), for which the employee:

- contributed with fraudulent behavior or gross negligence to the Group incurring significant financial losses, or by his/her conduct had a negative impact on the risk profile or on other regulatory requirements at Group or country/division level;
- engaged in misconduct and/or failed to take expected actions which contributed to significant reputational harm to the Group or to the country/division, or which were subject to disciplinary measures by the Authority;
- is the subject of disciplinary measures and initiatives envisaged in respect of fraudulent behavior or characterized by gross negligence during the reference period;
- infringed the requirements set out by articles 26 TUB and 53 TUB, where applicable, or the obligations regarding the remuneration and incentive system.

Malus mechanisms are also applied to take into account the performance net of the risks actually assumed or achieved, the performance related to the balance sheet and liquidity situation.

According to the EBA guidelines<sup>28</sup> and to further strengthen the governance framework, the key rules of compliance breaches management, as well as, their related impact on remuneration components, through the application of both malus and claw-back clauses, are given below.

Specific guidelines about the application of the Malus and Claw-back procedure to be adopted throughout the Group were formalized and provided by the Holding Company to the Legal Entities that apply local adaptations consistent with the overall Group approach and with regulations in the various countries in which the Group operates.

The process is specifically applicable to the Material Risk Takers population, as per regulatory provisions, while general principles are applicable to all individuals within the Group who are beneficiaries of variable remuneration, including external networks and agents, where applicable.

The main elements of the Malus and Claw-back procedure are the following:

- breaches identification, based on the roles and responsibilities of the functions involved according to their ordinary activities. The identification is based both on internal and external sources (e.g. special investigation, disciplinary sanctions, regulatory sanctions);

- breaches evaluation, based on the assessment of the breach materiality following a scoring system, from lowest to highest value. The drivers of materiality assessment are:

- severity of the individual conduct, including the circumstances of a law violation;
- adherence to the "Ethics & Respect" values and "Do the right thing" principle;
- nature (fraud or gross negligence) of the trigger event;
- repetitiveness of the breach;

- impact on financials;
- seniority of the individual;
- organizational role;
- impact on the group external reputation;
- other circumstances aggravating or mitigating the reported breach;
- in coherence with the score assigned and the reference period of the breach, the impact on the variable remuneration is defined according to two elements:

- perimeter of the variable remuneration (upfront or deferred) that can be reduced/cancelled based on predefined scenarios, according to the breach materiality. In case of heavy breaches, fulfilling certain pre-conditions, the claw-back (return) of already paid variable remuneration may be activated;
- percentage of the variable remuneration that can be reduced/ cancelled and/or returned back;

- breaches evaluation and final proposal for measures to be adopted are defined by a dedicated "Malus & Claw-back Committee" composed by representatives of Compliance, Human Capital and Internal Audit functions and, upon request, other UniCredit or other Group Legal Entities' personnel;
- decision making process and relevant measure adoption are defined according to the internal HR Delegation of Powers.

For Executive Directors and Executives with Strategic Responsibilities specific contractual provisions are envisaged, that allow the Company to ask the return, partially or totally, of the variable remuneration components already paid (or retain deferred amounts), defined according to data proved to be manifestly incorrect at a later time and other circumstances which may have been identified by the company.

28. "Guidelines on sound remuneration policies", published on June 27, 2016.

## 5.2 Performance Management framework

### 5.2.1 The Framework

The Group Incentive System, described in paragraph 5.1, is supported by an annual performance measurement framework assuring coherence, consistency and clarity of performance objectives with business strategy, while encouraging and rewarding desired behaviors and risk orientation.

Performance is evaluated in terms of risk-adjusted profitability and risk-weighted systems and mechanisms are provided.

The performance management process ensures all Material Risk Takers know what is expected of them and includes a rigorous monitoring of their goals achievements.

For the Group Material Risk Takers, for whom variable remuneration is expected to be more in line with long-term value creation and Group results, the process of setting annual objectives (so-called Goal Setting) is supported by a structured framework that has been consolidated over the years, namely the KPI Bluebook.

The KPI Bluebook serves as the performance measurement and evaluation framework within the Group Incentive System, which is reviewed and updated annually with the involvement of certain key functions (i.e. Human Capital, Finance, Risk Management, Compliance, Group ESG Strategy, & Impact Banking).

The KPI Bluebook provides specific guidelines related to:

- the selection of goals based on year-to-year priorities defined by business/division and the assignment of individual goals customized on the single position;
- the indication of measurable goals, both qualitative and quantitative. In case of customized goals, clear and pre-defined parameter for future evaluation performance shall be set and made transparent;
- balanced use of economic and non-economic goals, taking into account the single role's specificities;
- the use of risk-adjusted related goals (e.g. at least one KPI);
- the use of sustainability objectives for value creation over time (e.g. around half of the goals - among those based on priorities and annual strategies of Group/business/division - shall be related to sustainability);
- the use of goals related to conduct a compliance culture (i.e. KPI "Tone from the Top" mandatory for all Group Material Risk Takers)
- the selection of goals for the Corporate Control Functions, in order to ensure their independence (e.g. avoid KPIs linked to economic measure, use KPIs independent of results of monitored areas to avoid conflict of interests);

- the selection of goals, defined in a perspective of avoidance of conflicts of interest with customers, particularly for Commercial/Network roles.

The KPI Bluebook includes KPIs certified by relevant functions among which:

Main core drivers categories	Examples of KPIs for each category
Value creation	<ul style="list-style-type: none"> <li>ROAC (Return on Allocated Capital)</li> <li>RACE (Risk Adjusted Capital Efficiency)</li> <li>ROTE (Return on Tangible Equity)</li> <li>...</li> </ul>
Risk and capital governance	<ul style="list-style-type: none"> <li>CET1 ratio fully loaded</li> <li>New business EL %</li> <li>Performing Stock EL %</li> <li>NPE ratio</li> <li>...</li> </ul>
Clients	<ul style="list-style-type: none"> <li>Internal Service Quality (ISQ)</li> <li>Reputation Index</li> <li>External Customer satisfaction Index (e.g. NPS)</li> <li>Quality claims management and response quickness</li> <li>...</li> </ul>
Industrial levers	<ul style="list-style-type: none"> <li>Operating costs</li> <li>Cross-selling excellence (CSE)</li> <li>Underlying Net Profit</li> <li>Innovation and digitalization of processes and products</li> <li>...</li> </ul>
Human capital	<ul style="list-style-type: none"> <li>Human Capital Value &amp; Inclusion</li> <li>Gender Balance &amp; Pay Gap</li> <li>HR Processes Execution</li> <li>Succession Planning</li> <li>...</li> </ul>
Compliance culture	<ul style="list-style-type: none"> <li>Tone from the Top</li> <li>Regulatory requirements and policy implementation</li> <li>...</li> </ul>
...	<ul style="list-style-type: none"> <li>Cross Functional Collaboration and Best Practice Sharing</li> <li>...</li> </ul>

The different categories of the KPI Bluebook represent economic and non economic goals and are mapped into clusters of business, as shown in the picture below, to help identifying the most relevant standardized KPIs (all certified by relevant functions), with specific focus on risk-adjusted, sustainability-driven metrics and economic measures.

Sustainability KPIs (see Focus area) are the goals that meet current

### FOCUS

#### Stakeholder Value and Indicators

The KPI Bluebook includes also sustainability indicators aiming at

**Customer experience & brand reputation benchmarking**

- Definition analysis of competitive positioning of UniCredit on strategic KPIs, such as customer experience and brand reputation, assessing brand & business perception among Customers and Prospects;

**Customer experience & brand reputation benchmarking**

- Listening Methodology: the assessment is conducted in all countries where the Group operates as commercial bank, through surveys that involve the Retail and Corporate segment. Respondents are customers of the banks of UniCredit and of the local competitors and are contacted by the Provider randomly in a double blind approach (no list of clients contacts provided by UniCredit and no specification that UniCredit is the commissioner of the study);

**User/Jobseeker:**

- Strategic Net Promoter Score (S-NPS) as assessing the likelihood of recommendation of the local bank by its customers;
- Reputation Index, assessing the overall reputation of the local bank vs peers by customers & prospects;

**Supplier/Kentlar:**

#### CLIENTS

#### Internal service quality

**Definition:** analysis of an overall satisfaction perceived by the Internal Customer, evaluating the Department which is providing the service. Purpose is to simplify the process and improve its effectiveness. In addition, specific employee experience may be measured, evaluated by the employee quickly after the experience took place.

**Listening Methodology:** the assessment is conducted on the major Group perimeter, through a periodic web survey, on employees who have used the respective service as:

- User/Jobseeker: Overall Satisfaction for employees;
- Supplier: NetNDCX.

#### HUMAN CAPITAL

#### Succession Planning

**Definition:** the succession planning coverage ratio allowing to calculate the percentage of about 5,000 senior management Group positions for which a successor pipeline has been identified. The aim is to assure a sustainable leadership pipeline;

**Methodology:** the succession plan analysis follows a structured process based on Executive Development Plan (EDP) outcomes;

**Provider:** Internal. The Coverage Ratio is yearly shared with the Corporate Governance, Nomination and Sustainability Committee and then with the Board of Directors at the end of the process.

**With reference to 2020:** as shared with the Board of Directors, 100% of the strategic positions has a formalized succession plan.

#### EDP AT A GLANCE

EDP is the Group Management Review process which allows to plan, manage and develop the Group Leadership pipeline:

- ~ 2,200 Executives involved during the EDP session across the Group;
- Local EDP sessions to discuss all the EDP
- The Top Management positions subject to the discussion with the Group Chief Executive Officer.

#### Gender Balance

**Definition:** year-on-year trend in the percentage of women in Executive Vice President and Senior Vice President positions;

**Methodology:** the research is run for Group employees, through a recurring web survey internal analysis by the Human Capital function of the female representative by levels of the Global Job Model.

#### WOMEN IN SENIOR LEADERSHIP ROLES

In 2018, UniCredit signed the UK's HM Treasury Women in Finance Charter to pledge its full support to helping improve gender diversity in the financial services sector worldwide. Under this circumstance, UniCredit decided to set up a target of 20% women in Senior Leadership roles (Executive Vice President and above) by 2022. An additional 30% target has been added for the same positions by 2023.

needs without compromising the ability of the Company to generate profit in the future and which have an impact on the creation of medium/long-term value for one or more stakeholders.

In general, the KPI Bluebook, in addition to being the reference catalogue for the assignment of objectives within the Group Incentive System, can also be applied to the assignment of annual objectives for all Group personnel.

measuring client experience, employees' engagement level and Succession Planning. Further details on the sustainability strategy are included in the Integrated Report published on UniCredit website.

**5.2.2 2021 Goal Setting Framework**

The annual objectives are defined starting from the business strategy and in compliance with the KPI Blueprint framework described above. The process starts with the definition of the

objectives of Top Management, which serves as a starting point for the cascading of objectives to Group Executives and lower levels, where applicable. Below is the illustrative structure of the top level objectives.

**Overview on 2021 Goal Setting for Executives with Strategic Responsibilities**

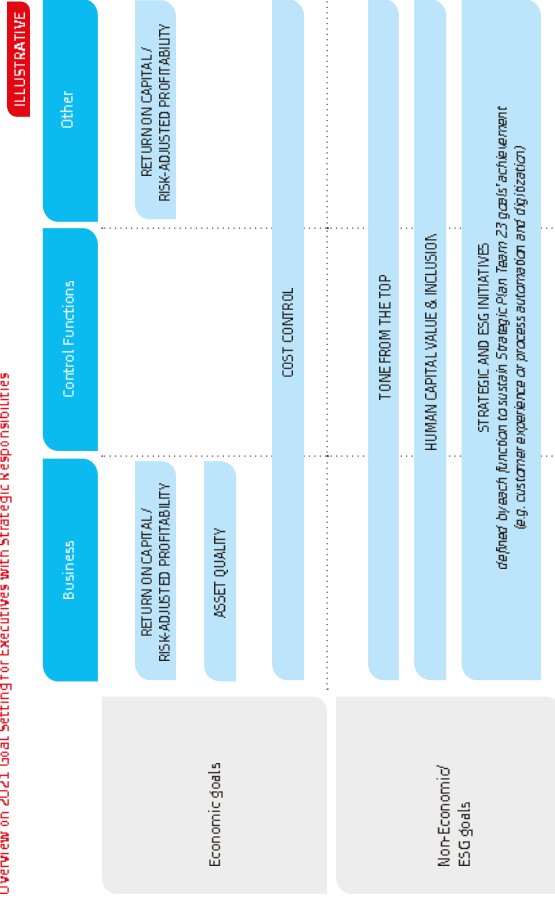

Economic objectives, with different weightings depending on the role and in compliance with regulations for the Corporate Control Functions, include objectives such as risk-adjusted profitability, return on capital, cost control and asset quality.

Among the non-economic objectives for the Group Material Risk Taker population, a specific KPI "Tone from the Top" is mandatory, related to integrity towards conduct principles and spread of compliance and risk culture (e.g. customer protection, financial crime prevention, cyber-security, climate risks and sustainability) as well as adherence to the values embedded into the "Ethics & Respect – Do the right thing!" Group principle to enhance overall organization awareness on these topics within the risk management framework.

In addition, to support UniCredit's commitment to people management and inclusion initiatives, including gender representation, as an enabler of the Bank's specific "Human Capital Value & Inclusion" target has been further detailed for Executive Vice President and above population, which can also be assigned to lower levels in order to generate a sustainable pipeline. In addition

to the percentage of women in Senior Leadership roles, to gender pay gap/balance targets and gender diversity initiatives, assigned to Top Management, the objective addresses the strategic workforce planning as well as employee safety and well-being during the pandemic and the transition to remote working by fostering people's engagement and providing opportunities for remote social interaction.

Finally, for Top Management an annual objective for the implementation of group strategies is defined, customized on the specific role and with reference to targets linked for example to the customer experience, automation, digitalization of processes and excellence of their function. Particular focus is given to ESG initiatives, such as the development of business strategy to generate new opportunities, strengthen brand recognition and ESG positioning, or the contribution to the reduction of environmental impact through a strengthened digital approach and remote customer interaction. Strategic initiatives are calibrated and cascaded within the managerial chains.

Each objective is assessed on a 5-point rating scale ranging from a minimum of "below target goal" to a maximum of "greatly exceeds target goal". For economic objectives with quantitative targets, defined by the designated functions (e.g. CFO, Risk Management), "suggested evaluations" are provided in support of the managerial evaluation, based on the percentage of achievement/deviation

compared to the target assigned. These suggested evaluations are defined by the competent functions and validated within a process that also involves the Human Capital and Compliance functions. Below are illustrated the objectives assigned to Executives with Strategic Responsibilities grouped by role:

**2021 Goal Setting for Executives with Strategic Responsibilities - Business functions**

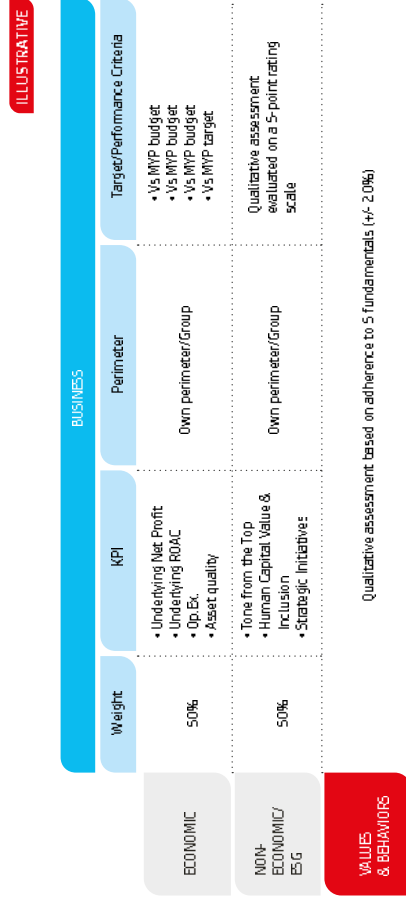

**2021 Goal Setting for Executives with Strategic Responsibilities - COO area**



2021 Goal Setting for Executives with Strategic Responsibilities - Finance & Controls, Competence Lines and Corporate Control Functions

ILLUSTRATIVE

FINANCE & CONTROLS, COMPETENCE LINES AND CORPORATE CONTROL FUNCTIONS			
Weight	KPI	Perimeter	Target/Performance Criteria
ECONOMIC 30%-40%	<ul style="list-style-type: none"> <li>Underlying ROAC<sup>A</sup></li> <li>Op.Ex<sup>B</sup></li> <li>FTE and NHR cost efficiency</li> </ul>	Own perimeter/ Group	<ul style="list-style-type: none"> <li>Vs. NWP budget</li> <li>Vs. NWP budget</li> <li>Vs. Qualitative assessment</li> </ul>
NON-ECONOMIC/ ESG 70%-40%	<ul style="list-style-type: none"> <li>Tone from the Top</li> <li>Human Capital Value &amp; Inclusion</li> <li>Strategic Initiatives</li> </ul>	Own perimeter/ Group	Qualitative assessment evaluated on a 5-point rating scale
VALUES & BEHAVIORS	Qualitative assessment based on adherence to 5 fundamentals (+/- 20%)		

A. Assigned to Finance & Control only  
 B. Not assigned to Head of Internal Audit

### 5.3 2020-2023 Group Long Term Incentive Plan

The 2020-2023 Group Long Term Incentive Plan (2020-2023 LTI Plan), approved by the Board of Directors on December 2, 2019, aims at aligning Top and Senior Management interests to the long-term value creation for the shareholders, to share price and Group performance appreciation and sustaining a sound and prudent risk management, orienting the performance management measurement on a multi-year horizon, aligned with Team 2.3 Strategic Plan.

The Plan also has the characteristic to be qualified as a "retention" tool in order to retain Key Players for the achievement of the mid-long term Group strategy.

The 2020-2023 LTI Plan provides for the allocation of UniCredit free ordinary shares, in several instalments and over a multi-year period, subject to the achievement of specific performance conditions linked to the 2020-2023 Multi-Year Plan.

#### 2020-2023 LTI Plan Beneficiaries

Senior Executive Vice Presidents of UniCredit  
 Executive Vice Presidents of UniCredit  
 and of the Legal Entities of the Group

Other key players ~200 beneficiaries, including selected Talents not belonging to the aforementioned clusters

The personnel belonging to Corporate Control Functions (i.e. Risk Management, Compliance, Internal Audit), Human Capital function and the Manager in Charge of Drafting the Company Financial Reports "Diligence Preposto" are not included in the Plan.

#### 2020-2023 LTI Plan: main Features

Reference amount at stake <sup>A</sup>	<ul style="list-style-type: none"> <li>Up to 50% of variable remuneration for SEVPs of UniCredit Group</li> <li>Up to 30% of variable remuneration for EVPs of UniCredit and of the Legal Entities of the Group</li> <li>Smaller amount for Key Players</li> </ul>
Performance period	4 years (aligned to UniCredit Strategic Plan Team 2.3)
Deferral period	<ul style="list-style-type: none"> <li>4 years deferral subject to "malus" conditions<sup>B</sup></li> <li>Additional compulsory holding year (after which the shares become free to sell, only if the share ownership guidelines are respected)</li> </ul>
Performance awards	<ul style="list-style-type: none"> <li>One award based on:                             <ul style="list-style-type: none"> <li>Gateway conditions on profitability, liquidity, capital and risk position</li> <li>Achievement of a set of performance conditions focused on Group targets, aligned to the Strategic Plan Team 2.3</li> </ul> </li> </ul>
Vehicles and vesting	<ul style="list-style-type: none"> <li>100% UniCredit Shares</li> <li>Ratable vesting for SEVP and EVP</li> <li>Claw-back rules apply 5 years after each installment, regardless of the vesting scenario</li> </ul>

A. Defined upfront on the basis of four years compensation  
 B. Malus conditions that reduce the payable amount based on profitability, liquidity, capital position  
 C. 100% upfront vesting for Key Players not considered risk-takers.

The different percentages of payments in shares, starting from 2024, are defined considering beneficiary categories, as described in the table below.

The awarded shares will be subject to a 4-year deferral period from the date of the award of the LTI Plan, as required by law.

The overall final amount of assigned shares will be defined on the basis of the achievement of specific performance conditions linked to the 2020-2023 Multi-Year Plan, subject to continuous employment at each date of assignment of the shares.

Moreover, the shares will be assigned only on the basis of the respect, during the performance period, of the minimum conditions of profitability, capital requirements and liquidity as well as positive RAF measured across the performance period, defined yearly or for the whole performance period, in addition to the respect of the conduct of

compliance with respect to the law, Company and Group compliance rules, Company Policies and to the C company values mentioned in the Code of Conduct (including claw-back clauses).

With reference to the performance period, if the threshold for the profitability conditions is not reached (either cumulative or in 2023), the award will be zeroed; on the other hand, the failure to reach the threshold for the other conditions to be assessed at the end of each year, implies the pro-rata reduction of the incentive.

With reference to the deferral period, if the thresholds for profitability, capital or liquidity conditions are not reached, the award will be reduced from 50% to 100%, based on the assessment of the General context in which the results have been generated.

The claw-back rules are applied for the next five years to all payments regardless of the specific deferral scheme.

Evidence of misconduct or gross negligence by the beneficiary during the performance, deferral and claw-back period (e.g. breach of code of conduct and other internal rules, especially concerning risks) will trigger malus & claw-back conditions.

It is expected a correlation mechanism with risk, based on a qualitative assessment of the Risk Appetite Framework and carried out through the annual risk dashboard during the Plan time horizon. Based on this assessment, a progressive reduction of the incentive can be envisaged until the complete zeroing.

It is foreseen that the Board of Directors will also carry out a final assessment on the basis of the value creation for shareholders (i.e. Total Shareholder Return) in relative terms and on a comprehensive evaluation of the overall performance achieved during the Plan period, also based on other managerial KPIs included in the MYP, market

context and compensation trends, reputational impacts, risks, relative Return on Tangible Equity (ROTE), innovation and digitization level of the Bank. Such assessment may lead to a decrease down to "zero" or an increase up to maximum 20% of the shares to be awarded under the Plan. However, the overall final number of shares assigned under the LTI Plan may, in no event exceed the maximum 1000% of the shares for which each beneficiary is eligible.

Once the Board verifies the achievement of the performance indicators, the shares awarded to each beneficiary will actually be assigned on the basis of the deferred instalments foreseen for the different beneficiary categories.

For the purpose of determining the number of shares to be awarded the below performance indicators specified in the LTI Plan are considered:

2020-2023 LTI Plan



2020-2023 LTI Plan Scorecard

Lower and KPIs	Weight	Target	Criteria	Payout
Profitability	60%	81.1% average 20-23	> 8.1% 7.3%-8.3% < 7.3%	> 100% 0-100% 0%
Asset Quality	20%	3.8% average 20-23	< 3.6% 4.2%-3.6% > 4.2%	> 100% 0-100% 0%
Industrial	10%	0.39% average 20-23	< 0.39% 0.44%-0.39% > 0.44%	> 100% 0-100% 0%
Sustainability	10%	10.2 bin end of 23	< 10.2 bin 10.5-10.2 bin > 10.5 bin	> 100% 0-100% 0%
			1 <sup>st</sup> -2 <sup>nd</sup> in ranking	150%-125%
			3 <sup>rd</sup> in ranking vs. peers end of 23	100%
			4 <sup>th</sup> in ranking	75%
			5 <sup>th</sup> in ranking	50%
			below 5 <sup>th</sup>	0%
			> +3 pts	> 100%
			+1 pt. + 3 pts	0-100%
			< 1 pt	0%
			> 73 pts	> 100%
			71-73 pts	0-100%
			< 71 pts	0%

Note: Data within the table are equally weighted, our performance (NRO) above MYP target can be used to compensate the risk, their cash at least their minimum threshold level. A: within the minimum 100% opportunity of the LTI Plan. B: Bonus cap for CET1 at least 200 bps above minimum regulatory target C: Without credit impact

The awarded shares will be subject to a 4-year deferral period from the date of the award of the LTI Plan, as required by law.

The overall final amount of assigned shares will be defined on the basis of the achievement of specific performance conditions linked to the 2020-2023 Multi-Year Plan, subject to continuous employment at each date of assignment of the shares.

Moreover, the shares will be assigned only on the basis of the respect, during the performance period, of the minimum conditions of profitability, capital requirements and liquidity as well as positive RAF measured across the performance period, defined yearly or for the whole performance period, in addition to the respect of the conduct of

compliance with respect to the law, Company and Group compliance rules, Company Policies and to the C company values mentioned in the Code of Conduct (including claw-back clauses).

With reference to the performance period, if the threshold for the profitability conditions is not reached (either cumulative or in 2023), the award will be zeroed; on the other hand, the failure to reach the threshold for the other conditions to be assessed at the end of each year, implies the pro-rata reduction of the incentive.

With reference to the deferral period, if the thresholds for profitability, capital or liquidity conditions are not reached, the award will be reduced from 50% to 100%, based on the assessment of the General context in which the results have been generated.

The claw-back rules are applied for the next five years to all payments regardless of the specific deferral scheme.

2020-2023 LTI Plan



Note: Data within the table are equally weighted, our performance (NRO) above MYP target can be used to compensate the risk, their cash at least their minimum threshold level. A: within the minimum 100% opportunity of the LTI Plan. B: Bonus cap for CET1 at least 200 bps above minimum regulatory target C: Without credit impact

The award is confirmed at the end of the Multi-Year Plan if the above performance criteria and the Gateways & Risk Adjustments are confirmed.

The awarded shares will be paid in line with the payout scheme described above and subject to the malus and claw-back conditions. As required by law, each share payment is subject to a share retention period of one year.

Share conversion price was defined on the basis of the average price of shares during the 30 days prior to the Board of Directors of January 14, 2020 approving the remaining details concerning the Plan (including the share conversion price) that equals € 13.306.

The maximum number of UniCredit shares to be allocated under the Plan is equal to 9,400,000 shares.

The 2020-2023 LTI Plan envisages an expected impact on UniCredit share capital of approximately 0.42%, assuming that all the free shares will be assigned to employees. The total dilution for all share plans currently in place, including 2020-2023 LTI Plan, equals to 2.50%.

The Board of Directors will assign free UniCredit ordinary (and freely transferable) shares to the beneficiaries at latest by the end of July of the year following the one of each up-front or deferred share instalment (e.g. the "up-front" share instalment vested in 2024, at the end of the Plan, will actually be assigned to the Beneficiaries by the month of July 2025).

In case of termination of the employment relationship, the Beneficiary shall keep all rights under the Plan provided that he/she qualifies as a Good Leaver. Specifically, in case of Good Leaver, if this occurs during the performance period, the Beneficiary will be entitled to a pro-rata

temporis award of the shares, subject to the achievement of relevant performance conditions at the end of the performance period and according to the deferred payout scheme and all other terms and conditions under the Rules of the 2020-2023 LTI Plan. For the purpose of the Rules, a "Good Leaver" is exclusively a Beneficiary who ceases to be an Employee of the Company during the Plan due to the following reasons:

- termination of the employment relationship due to any physical impediment, including ill-health, injury or permanent disability, as established by applicable laws;
- retirement, also in case of agreement with the Company and/or enrollment into early retirement or redundancy plans;
- the company employing the Beneficiary ceases to be a member of the Group;
- a transfer of the undertaking, or the part of the undertaking, in which the Beneficiary works to a person or legal entity which is not a member of the Group.

The status of "Good Leaver" may also be granted, taking into account the specific circumstances and the company's interest, within the scope of specific agreements entered into with the beneficiary.

During the implementation phase, potential changes can be made to the LTI Plan, in order to ensure compliance with the laws and regulations from time to time in force in the countries where the Group Legal Entities are established<sup>28</sup>.

<sup>28</sup> Such amendments shall be adopted in accordance with the provisions applicable and in particular with the "Disposizioni di vigilanza per le Banche in materia di pratiche e prezzi di remunerazione e incentivazione" (Circular 285 of December 17, 2015), L. 22/10/2015 n. 188.



# Remuneration Report

- 1. Introduction**
- 2. Governance**
  - 2.1 Report on the Remuneration Committee
  - 2.2 Role of Corporate Control Functions and other relevant functions
- 3. Remuneration Processes and Outcomes**
  - 3.1 2020 Incentive System Implementation and outcomes
  - 3.2 Group Long Term Incentive Plans status update
  - 3.3 Group Material Risk Takers Identification process outcomes
- 4. 2020 Remuneration Data**
  - 4.1 Compensation to Directors, Statutory Auditors and Executives with Strategic Responsibilities
  - 4.2 Granular Remuneration Data

# 1. Introduction

*The Remuneration Report discloses all relevant Group compensation-related information and methodologies with the aim of increasing stakeholders' awareness of the compensation, practices and outcomes in UniCredit, demonstrating their coherence with the business strategy and performance and the sustainability over time, responsible remuneration and sound risk management.*

The report provides ex post information on 2020 outcomes, covering both the Group Material Risk Taker population and corporate bodies members. Remuneration solutions implemented in 2020 provided for:

- compliance of incentive structures with all relevant regulations, including deferred and equity incentives based on financial instruments;
- comprehensive performance measurement to foster sound behaviors aligned with different types of risk.

The disclosure provided within the Remuneration Report considers the:

- alignment to the national and international regulatory provisions in force;
- continuous monitoring of market trends and practices, supported by Willis Towers Watson, as external advisor of the Remuneration Committee as well as other national and European Banking Associations;
- annual engagement process with international investors and proxy advisors.

The activities performed in 2020 from a compensation standpoint are in line with the 2020 Group Remuneration Policy, which was built based on national and international regulatory framework, as made available along the years:

- on January 1, 2014 the Capital Requirements Directive (CRD IV) was implemented, providing a cap on variable remuneration for Material Risk Takers and requesting local regulators to issue regulations for local implementation;
- on March 4, 2014 the European Commission issued the Delegated Regulation (EU) 604/2014, with regard to regulatory technical standards (RTS) to identify Material Risk Taker population;
- on June 27, 2016 EBA published the document "Guidelines on sound remuneration policies".

In particular, date pursuant to sect. 84-quarter Consob Issuers Regulation Nr. 11971, Compensation Report-Section II (last modified under resolution no. 21623 of December 10, 2020), as well as the information on incentive systems under 114-bis<sup>2</sup> are included in the attachments to the 2021 Group Remuneration Policy and Report, published on UniCredit website, in the section dedicated to the Shareholders' Meeting.

Moreover, to be noted a positive feedback gathered during the shareholders' General Meeting held on April 9, 2020 on the Remuneration Report on 2019, with an approval percentage higher than 95%.

UniCredit also interacted with Regulators to properly consider issued recommendations.

The Remuneration Report, a document providing complete and comprehensive information on compensation, includes also this year details referring to Members of Administrative and Auditing bodies, General Managers and Executives with Strategic Responsibilities.

• on October 23, 2018 Bank of Italy published the 25th update to Circular 285 on remuneration and incentive matters, already incorporating the CRD IV provisions;

• on March 19, 2019 Bank of Italy issued the provisions on "Transparency of banking and financial transactions and services - Fairness of relations between intermediaries and clients", applicable from 2020;

• on December 10, 2020 Consob Issuers Regulation Nr. 11971 was updated under resolution no. 21623 to transpose the Directive (EU) 2017/828 (Shareholders Rights Directive II) requirements of May 17, 2017 already implemented in the legal system with the Legislative Decree no. 49 of May 10, 2019.

During 2020, there were a few ECB recommendations on variable remuneration which were fully considered during the decision-making process.

In 2020, we participated in the European Banking Authority's remuneration benchmarking exercise and data collection of high earners, reporting through Bank of Italy, information regarding remuneration for 2019 of all staff and Group Material Risk Takers, including the number of individuals in pay brackets of at least 1 million Euro.

In 2020, in continuity with the past, UniCredit interacted with the Remuneration Committee external advisor which provided with:

- recommendations on remuneration based on specific benchmarking analysis versus our defined peer group to inform any decision, also related to Group Executive population;
  - analysis on emerging trends in market compensation practices; with the goal to improve Group policies and practices.
- In 2020 and in the first months of 2021, UniCredit continued its annual structured dialogue with the international investors and proxy advisors, as well as national and European Banking Associations, receiving valuable feedback on the compensation approach and specific inputs for an effective compensation disclosure, considering Italian and international standards.

1. Guideline on sound remuneration policies under article 74(8) and 74(9) of Directive 2013/36/EU and disclosure under article 44(5) of Regulation (EU) No 575/2013.

2. Legislative decree no. 58 of February 24, 1998 as well as the provisions of the issuer "Regulations" adopted by UniCredit with resolution no. 11971 of May 14, 1999 regarding the information to be disclosed to the market in relation to the granting of variable remuneration plans based on financial instruments.



Remuneration Committee (year 01/10/2020 - 31/12/2020)

	Independency according to Articles of Association and Code	Non-Executive	Office covered C= Chairman M= Member	Nr. of attended meetings	% of participation
Andreotti Lamberto Chairman	✓	✓	C	10	100%
Carletti Elena Director	✓	✓	M	10	100%
Zambon Elena Director	✓	✓	M	6	85.7%
De Giorgi Diego Director	✓	✓	M	2	100%

**C** Chairman **M** Member

A. office held until October 15, 2020  
B. office held since November 4, 2020

## 2.2 Role of Corporate Control Functions and other relevant functions

Group Compliance function's key contributions in 2020 included:

- evaluation of the 2020 Group Remuneration Policy and Report submitted to the Board of Directors for subsequent approval at the Annual General Meeting on April 9, 2020;
- evaluation of the 2020 Group Incentive System for Group Material Risk Takers;
- preparation - in collaboration with Human Capital function - and distribution of Group guidelines for the development and management of 2020 incentive systems for below Executive population;
- participation in specific initiatives of Human Capital function (e.g. review of *Risk Bluebook*; review of definition of Group Material Risk Takers for the application of Group Incentive System);
- analysis of specific non-standard compensation within the 2020 cycle.

In 2020, to ensure the link between compensation and risk, the Group Risk Management function was involved:

- in compensation design and in the definition of an explicit framework to develop remuneration within an overarching Group Risk Appetite Framework;
- in the definition/update of the Group Incentive System entry conditions;
- in the definition of KPIs, part of the *Risk Bluebook*, identified as risk-related;

so that incentives in taking risk are appropriately counterbalanced by incentives in managing risk.

Additionally, the Group Chief Risk Officer was invited to attend Remuneration Committee meetings to ensure that incentive schemes are appropriately updated to take into account all of the risks that the Bank has taken on, pursuant to methodologies in compliance with those adopted by the Bank in managing risk for regulatory and internal purposes.

Group CFO function contributed to 2020 compensation processes mainly through the definition of:

- Group Incentive System entry conditions;
- bonus pool funding KPIs and
- performance Scorecard KPIs for Group Material Risk Taker population, also providing the relevant budget and actual data.

Furthermore, the Group Chief Financial Officer attended the Remuneration Committee meetings in occasion of the presentation of the company performance, which determines the size of the bonus pool.

In particular, the Board of Directors and Remuneration Committee draw upon the input of involved functions to define the link between profitability, risk and reward within Group incentive systems.

### Internal Audit report on the 2020 Remuneration policies and practices

Group Audit Department performed the annual audit on the Group remuneration policies and practices, requested by Bank of Italy<sup>2</sup>, aimed at verifying the design and implementation of the remuneration process, as well as its compliance with relevant regulatory requirements and Group internal rules.

The Internal Audit satisfactory evaluation was based on the overall correct application of the Group Incentive System, including execution of decisions taken by UniCredit Remuneration Committee and Board of Directors.

Internal Audit verified the overall correct implementation of 2020 Group Remuneration Policy and the application of Group Incentive System rules to Group Material Risk Takers.

Internal Audit also verified the substantial adequacy of specific aspects of the remuneration process, such as Group Material Risk Takers identification, goal setting, bonus pool calculation and distribution, procedures to respect the caps of the ratio between variable and fixed components of remuneration, as well as payment and deferral phase of previous year incentive system.

Severances paid in 2020 resulted in line with the Group Termination Payments Policy and severance guidelines, respecting relevant escalation processes and informing Remuneration Committee.

Main audit results were presented to the Remuneration Committee on March 3, 2021.

3. Circular 285 December 17, 2013, 25<sup>th</sup> update of October 25, 2020

# 3. Remuneration Processes and Outcomes

## 3.1 2020 Incentive System Implementation and Outcomes

The 2020 system, approved by UniCredit Board of Directors on January 14, 2020, provided for a "bonus pool" approach that directly links bonuses with company results at Group and country/division level and ensures a strong connection between profitability, risk and policy and governance, provides for the allocation of a performance related bonus in cash and/or free ordinary shares up to six years.

UniCredit's annual incentive system is designed to align the interest of shareholders and management and to reward for performance. The 2020 UniCredit performance was affected by the Covid-19 pandemic emergency (Underlying NOP: - 63% vs. 2019), which in turn was reflected in the annual incentive system outcomes.

Consistently with the ECB (letters of May 20, July 28 and December 15, 2020) requiring for extreme moderation with regard to the variable remuneration payments, especially for Material Risk Takers, the 2020 bonus decisions consider a reduction of ca. 50% in the bonus of Group Material Risk Takers compared to budgeted figures with a proportionally higher reduction for senior executives.

Moreover, in this context, ECB issued a few recommendations on May 20, July 28 and December 15, 2020 on the subject of remuneration decision, asking for extreme moderation in the distribution of variable remuneration, especially for Material Risk Takers that were embedded in the decision-making process.

### ➤ Bonus pool sizing

The bonus pools dimension for each of the eight clusters was related to the actual profitability measures multiplied for the bonus pool funding rate defined in the budgeting phase. This calculation determined the so called "theoretical bonus pool" for each cluster that is adjusted accordingly to the actual trend of performance of the respective segment.

### ➤ 2020 Entry Conditions at group and local level

In order to align to regulatory requirements, specific indicators measuring annual profitability, capital and liquidity results had been

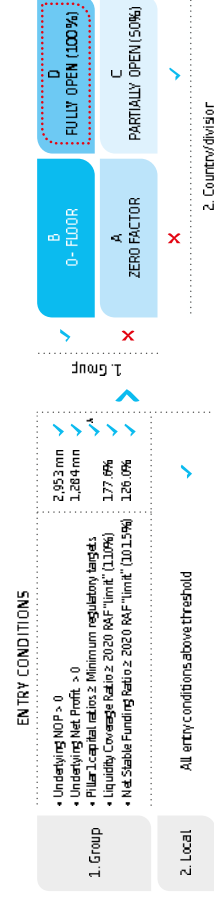

None values are at budget

A. Pillar 1 Capital Ratio (Transitional) = 15.99%, Tier 1 (Transitional) = 18.16%, Total Capital (Transitional) = 20.66%, Leverage Ratio (Transitional) = 61.9%, TLAC = 26.92%, Pro forma figures including the deduction of shares by back in amount of 17.7%, subject to supervisory and/or approval. Absorbed, as reported below, which considers a reduction of

### ➤ 2020 Group Incentive System rules application

As a consequence of Entry Conditions positive assessment both at Group and local level, all the eight bonus pools are in the fully open (100%) scenario.

2020 Group Incentive System rules therefore have been applied.

For each segment, the theoretical bonus pool value has been calculated applying the funding rate percentage to the actual profitability results.

The CRD "multiplier", even though was positive for most of the bonus pool clusters, was not activated due to the fact that the prerequisites in terms of EVA were not achieved.

In this context, the Remuneration Committee resolved to submit to the Board of Directors' approval bonus pool amounts grounded on performance results. In particular, the proposal submitted to the Board emerged in total bonus pool amount broadly in line with the total theoretical value (depending on the funding KPI which was highly affected by pandemic), mostly as a result of balancing per-capita bonus levels and performances within each country/division. The overall approved bonus pool of the segments by the Board of Directors, as per the Remuneration Committee proposal, considers a proportionally higher reduction for senior executives and Material Risk Takers, in line with ECB moderation recommendations and to preserve the reward for more junior non Material Risk Takers colleagues.

### ➤ Bonus pool distribution by segments

The results of the above-mentioned steps, led to the distribution of the bonus pool for the Group Material Risk Taker population (1,063 resources in 2020), as reported below, which considers a reduction of ca. 50% in the bonus of this population compared to budgeted figures, fully consistent with the company performance in terms of Underlying NOP.

For 2020, UniCredit Board of Directors took into consideration the Remuneration Committee's proposals and regulatory guidelines regarding variable remuneration.

The assessment related to remuneration decisions, as in previous years, has been supported by a strict Group governance process in order to guarantee consistency and transparency towards all parties involved in the decision-making process.

The total amount of variable compensation for Group Material Risk Takers, detailed in paragraph 4.2, is sustainable given the bank's financial position, does not limit the bank's ability to hold an adequate level of capital and liquidity and in line with ECB recommendations.

2020 Bonus distribution for GMRT

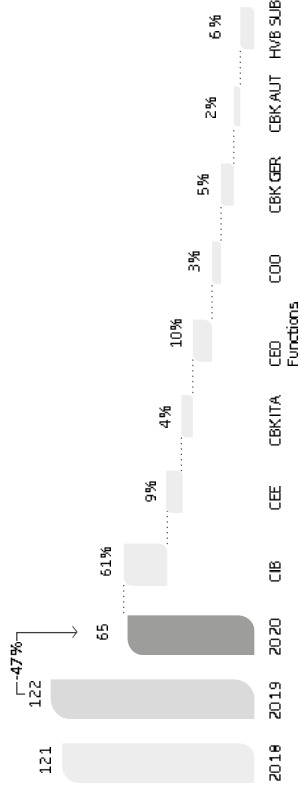

Data in the row for the 2020 year does not include the 11 private equity funds

Details »

For further details on the execution of the 2020 Group Incentive System and the deferrals of previous years' Plans, refer to Paragraph 4.2 and to the attachment to 2021 Group Remuneration Policy and Report, published on the UniCredit website, in the section dedicated to 2021 Shareholder's Meeting.

Execution of previous years plans

Upon the assessment of achievement level for goals defined for 2020 and subsequent governance step in the Board of March 5, 2021 the allocation of ca. 3.1 million UniCredit ordinary shares was promised to ca. 450 Group Material Risk Takers to be distributed in 2022, 2023, 2024, 2025 and 2026.

The actual allocation of the last four installments is subject to the application of Zero Factor for 2022, 2023, 2024 and 2025 respectively. Therefore, the 2020 Group Incentive System would entail an expected impact on UniCredit share capital of approximately 0.14%, assuming the achievement of Group performance thresholds without the application of Zero Factor scenario.

With reference to previous years Plans, the Board of Directors resolved to proceed with the payments of the outstanding deferrals due in 2021 (deferred from 2015, 2016, 2017, 2018 and 2019 Plans and from severance payments related to 2015, 2016, 2017, 2018, 2019 and 2020 Plans).

2020 fixed and variable compensation for the Chief Executive Officer

With reference to 2020, the Chief Executive Officer proposed to reduce his salary by 25 per cent, equivalent to 300,000 Euro.

The CEO variable remuneration in 2020 was impacted by his decisions linked to the pandemic as well as by the year-end events regarding his continuation in the role.

In particular, the CEO decided to waive his full variable 2020 LTIP equivalent to a maximum of 24 million Euro to sustain the health emergency.

Later in the year, on November 30, 2020, Jean Pierre Mustier announced that he would have retired from his role as Chief Executive Officer at the end of his mandate. While defining the exit conditions, it was agreed that he will maintain the variable remuneration deriving from the 2017-2019 Long Term Incentive Plan, which shares will be awarded according to the cliff vesting scheme and subject to malus and claw-back conditions, as legally enforceable. With regards instead to the 2020-2023 Long Term Incentive Plan, Mr. Mustier does not maintain any entitlement.

FOCUS

Severance Payments – Calibrations and exceptions

As provided by the Group Termination Payments Policy (Severance Policy), starting from its approval by 2019 Annual General Meeting, some calibrations, submitted to the Holding by non-Italian Group Legal Entities, were approved.

Most of the calibrations aim at ensuring the compliance with regulatory requirements, laws and practices of the local markets and, additionally to formal amendments, were related to the

- exclusion from the Severance Policy field of applicability of some categories/typologies of payments, being not discretionarily defined by laws and labor contracts;

- possibility not to apply deferral mechanisms and/or malus and claw-back clauses if not envisaged by local regulations or inconsistent with local labor laws.

With reference to Austria, in connection to the so called "protected" contracts ("Definitivum"), which cannot be unilaterally terminated by the Company before retirement, as provided by the Severance Policy paragraph 4.1.2, the maximum limit for severance payments has been raised from 24 to 36 months of total compensation.

For Germany, which is characterized by a particularly protective legislation with regard also to Executives, a calibration proposal was approved in compliance with paragraph 4.1.1 of the Severance Policy, allowing for the notice to be paid on top to the general limit of 24 months and - in exceptional cases and with particular governance - to also increase the maximum number of months to 36 or 48, depending on the circumstances. In consideration of this context, a change in the formula calculating the severance and the provision that the formula does not apply to the severance considered privileged based on local regulatory legislation was also approved.

None of the local calibrations and exceptions have an impact on the Executives with Strategic Responsibilities

During 2020, all severance payments were managed in line with the approved governance and all 33 Executive cases were managed in total consistency with the approved Policy.

For other details on severance payments defined in 2020 for Group Material Risk Takers refer to paragraph 4.2.

3.2 Group Long Term Incentive Plans status update

2017-2019 Group Long Term Incentive Plan

All malus conditions for the first year of deferral were fulfilled, therefore the tranches vesting in 2020 were confirmed.

2020-2023 Group Long Term Incentive Plan

An update on the LTIP Plan progress status was provided to the Remuneration Committee on February 9, 2021. All the entry conditions (gateways & risk adjustment) were met in 2020, while the Company results referred to the LTIP Plan KPIs are strongly affected by pandemic on the profitability side.

To illustrate the progress status, and with no impact on final assessment, 2020 results on the LTIP KPIs are:

- ROTE 2.5%;
- NPE Ratio "Core" 3.8%;
- Expected Loss new business flow 0.25%;
- OpEx 9.8 bn;
- ESG Sustainability Rating 5th in ranking;
- Customer Experience +4 pts vs. competition;
- People Engagement 70 pts.

The actual evaluation of the overall LTIP Plan, including the appraisal of performance targets, will be carried out at the end of the four-year performance period (i.e. at the end of 2023 on end-of-Plan targets).

4. In this context, Executives are the employees with global mandate equal to Senior Vice President or higher. For further information on the data used here, refer to Section 1 Chapter 1.

### 3.3 Group Material Risk Takers Identification process outcomes

On December 10, 2020, the Board of Directors, upon Remuneration Committee proposal, approved the outcomes of the second cycle of the identification process of the 2020 Group Material Risk Taker (GMRT).

The process led to the identification of 1,063 GMRT (1,76 of which new compared with last year and 1,64 resources identified for the first time), resulting in 43 resources more than the Group Material Risk Takers at the end of 2019. Approximately 500 resources (see also chart below) amongst the total of Group Material Risk Takers belong to the Business Functions, for whom the adoption of a maximum ratio between variable and fixed remuneration of 2:1 can be applied. Moreover, 39 resources are also defined as Group Material Risk Takers exclusively because of total remuneration levels.

Group Material Risk Taker population represented ca. 1.3% of the Group employee population, with this outcome being broadly in line with the results of 2019 process and slightly above the peers median.

At the end of 2020, there were no Agents and Financial Advisors identified within the Group Material Risk Takers as per EBA qualitative criteria (along the year an exclusion process for 9 agents and financial advisors was activated and completed).

Here below a representation of 2020 Group Material Risk Taker population.

#### 2020 Group Material Risk Taker Distribution

Geographical distribution of the Group Material Risk Taker

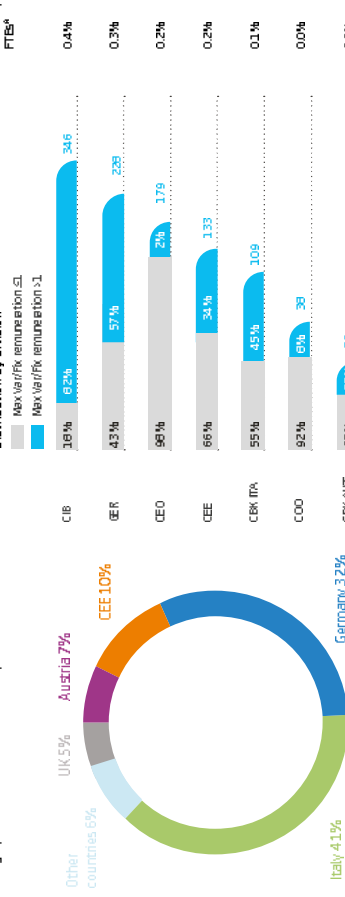

**TOTAL NUMBER OF GROUP MATERIAL RISK TAKERS<sup>A</sup>: 1,063 (OWW 1,64 IDENTIFIED FOR THE FIRST TIME)**

A. Data as of 30/09/2020, total number: 85,620  
B. Total number of officers does not include Group Management Board members nor employees of UniCredit Group

## 4. 2020 Remuneration Data

### 4.1 Compensation to Directors, Statutory Auditors and Executives with Strategic Responsibilities

#### 4.1.1 Board of Directors

The Ordinary Shareholders' Meeting held on April 12, 2018 appointed UniCredit's Board of Directors for the financial years 2018-2020 whose mandate expires upon approval of the 2020 financial statements. The Board thus elected was chaired by Mr. Fabrizio Saccomanni.

Following the sudden death of Mr. Saccomanni on August 7, 2019, Mr. Cesare Bisoni - Deputy Chairman - served as Chairman from August 8 to September 20, 2019, the date on which the Board of Directors appointed him to all intents and purposes Chairman of the Board of Directors.

On October 13 2020 the Board of Directors unanimously co-opted Professor Pier Carlo Padoan as a non-executive director after having concluded that he is the best candidate for the position as Chairman of UniCredit for the next term (2021-2023). Professor Padoan will serve as a Board member until the Shareholders' Meeting of April 15, 2021, called to approve the 2020 financial statements and at which a new Board of Directors will be elected.

On January 27, 2021, the Board of Directors of UniCredit also identified Mr. Andrea Orzi as the next Chief Executive Officer, to be included in the list of candidates for the renewal of the Board.

Prof. Padoan, as well as Mr. Orzi, were selected by the Board of Directors on the basis of the "Process for selecting candidates for the post of Chief Executive Officer, Chairman and Board member", approved by the Board itself and published on the Company's website.

The above-mentioned process will also be applied for the selection of the other candidates/Directors in the list that will be submitted by the Board to the next Shareholders' Meeting on April 15.

The Shareholders' Meeting of April 12, 2018 also approved the proposal, made by the outgoing Board, to grant to the members of the Board and its Committees an overall annual compensation of Euro 1,760,000, of which Euro 1,125,000 aimed at remunerating the members of the Board and Euro 635,000 at the remuneration of the members of the Board's Committees.

The same Shareholder's Meeting had also approved the granting of an attendance fee for the participation to each Board and Committee meeting formally convened, differentiated as reported below.

- Board of Directors and Internal Controls & Risks Committee: Euro 1,000 for the physical presence of the Director, Euro 400 if the participation occurs through means of remote communication means;
- other Board Committees: Euro 800 in case of physical presence of the Director, Euro 400 if the participation occurs through remote communication means.

In 2020, after Covid-19 outbreak for safety reason, all meetings were held via remote means and rewarded as per the physical presence fee.

It is recalled that members of the Board of Directors benefit from the insurance policy to cover the third party liability of Directors and Statutory Auditors.

The above overall compensation was then split by the new Board, that - in compliance with clause 26 of the Articles of Association - had also defined the remuneration of Directors vested with particular offices pursuant art. 2389, 3<sup>rd</sup> paragraph, of the Civil Code. Specifically, this total compensation was all located as follows:

- Euro 75,000 for each Board member;
- Euro 50,000 for each member of the Internal Controls and Risks Committee;
- Euro 35,000 for each member of the Remuneration, Corporate Governance, Nomination and Sustainability and Related-Party Committees.

Moreover, heard the opinion of the Board of Statutory Auditors, the Board had defined the following special remuneration ex art. 2389, 3<sup>rd</sup> paragraph of the Civil Code:

- Euro 775,000 for the Chairman of the Board, in addition to the insurance for non-occupational accidents;
- Euro 402,000 for the Chief Executive Officer (in 2020 the CEO waived Euro 300,000 to alleviate the impact of the pandemic);

Specifically for 2020, the individual goals of the Heads of the Internal Audit, Compliance Function, Risk Management (CRO), Group Human Capital and the Manager in charge of preparing the company's financial reports were not connected to the Company's performance.

► **Payout**

In line with Group governance, 2020 assessment and payment for the Executives with Strategic Responsibilities have been reviewed by the Remuneration Committee and approved by the Board of Directors, heard the Statutory Auditors and Internal Controls & Risks Committee as relevant.

It was foreseen the deferral/holding of ca. 75% of the incentive in 5 years, in cash and shares, with payout subject to the achievement of future performance conditions over the following financial years.

All the installments are subject to the application of malus and claw-back conditions, as legally enforceable.

Approximately 55% of the overall incentive is paid in UniCredit shares, whose number to be allocated in the respective installments are defined on the basis of the arithmetic mean of the official market price of UniCredit ordinary shares during the month preceding the Board to which the bonuses are submitted, after having evaluated performance achievements.

For further information on individual allocation related to the 2020 Group Incentive System, refer to the 2020 Group Remuneration Policy, Section 1, paragraph 5.1.

*De laets*  
Further information regarding the 2020 incentive plans implementation and outcomes is provided in paragraph 3.1 >>>

► **Shareholding requirements**

For the CEO and for other Executives with Strategic Responsibilities, share ownership guidelines are in place, further details in Section 1, paragraph 4.8. For them and for all the other Executives to whom the guidelines apply, share ownership levels have been verified at the end of October 2020.

For ~85% of the Executives the levels are already in line with the guidelines' requirements (the remaining Executives are below the threshold but accumulating shares).

In the following charts the synthetic information regarding the perceived remuneration for 2020 by the Directors, Statutory Auditors and Executives with Strategic Responsibilities is shown.

With reference to the following table, for Executives with Strategic Responsibilities it is specified that:

- the fixed component was defined taking into consideration market information and in such a way to be sufficient to reward the activity rendered even if the variable part of the remuneration package were not paid due to non-achievement of performance goals;
- in line with the latest regulatory requirements, the Chief Executive Officer as well as the other Executives with Strategic Responsibilities have a balanced part of their remuneration linked to the economic results of UniCredit, taking into consideration the overall profitability, weighted by risk and cost of capital, as well as sustainability goals (based on capital and liquidity ratios).

Considering the uncertain impact on the European economy of Covid-19 epidemic and its evolution over time, Top 7 Senior Managers reporting to the CEO decided to voluntarily waive their 2020 annual bonus, in line with the decision taken by the CEO to fully waive his yearly variable compensation and 25% of his salary for the year 2020.

With reference to the variable component and the weight of short-term and long-term components, the last one represented by the 2020-2023 LTI Plan tied to the Strategic Plan Team 2.3, the compensation pay-mix for Executives with Strategic Responsibilities in 2020 was:

- for the 7 Top Managers, fully LTI oriented (considering the waivers on STI);
- for the Heads of Corporate Control Functions and Head of Group Human Capital, based on STI (since LTI is not foreseen for them);
- for Head of Group Legal, equally balanced in terms of LTI and STI.

► **Goals**

In light of the above, the annual incentive took into consideration the achievement of specific goals which were previously approved by the Board upon proposal of the Remuneration Committee and the opinion of the Board of Statutory Auditors and the Internal Controls & Risks Committee, as appropriate.

Specific individual goals were set out taking into consideration the market practices and the role assigned within the Group, through the systematic use of specific indicators aimed at strengthening the sustainability of business, such as the customer satisfaction, risk and financial sustainability indicators and capital measures.

For the Heads of the Corporate Control Functions, pursuant to the provisions of Bank of Italy, the goals were established by the Board of Directors in line with the tasks assigned to them and avoiding goals linked to Bank's performance. In the decision making process related to Corporate Control Functions, the Board of Statutory Auditors and the Internal Controls & Risks Committee were also properly involved.

To the Shareholders' Meeting of April 11, 2019 was also communicated that:

- the annual remuneration approved by the Shareholders' Meeting of April 14, 2016 for the outgoing Board of Statutory Auditors was Euro 140,000 for the Chairman of the Statutory Auditors and Euro 100,000 for each permanent Auditor, as well as an attendance fee of Euro 400 for each Board of Statutory Auditors meeting and of Euro 400 as attendance fee for taking part in any meeting of the other corporate bodies;

the annual remuneration approved by the Board of Directors on June 13, 2018 for the external members of the Supervisory Board was Euro 50,000 for the Chairman and Euro 40,000 for each external member;

- the Shareholders' Meeting held on May 11, 2012 resolved to renew the terms of the insurance policy to cover the third-party liability of the Company's Directors and Statutory Auditors and that this insurance would be extended to the Statutory Auditors appointed on this occasion.

On the basis of this information - and taking specific account of the fact that, as from this renewal, the Board of Statutory Auditors would also perform the functions of the Supervisory Board - a shareholder of UniCredit SpA has proposed to the Shareholders' Meeting, which has approved, an annual remuneration of:

- Euro 170,000 for the Chairman of the Board of Statutory Auditors;
- Euro 125,000 for each permanent Auditor;

plus an attendance fee of Euro 400 for every meeting of the Board of Statutory Auditors and an attendance fee of Euro 400 for any other meetings of a company body attended.

**4.1.3 Executives with Strategic Responsibilities**

► **Pay-mix**

For 2020, according to the Group Remuneration Policy, in line with regulatory provisions, the maximum ratio between variable and fixed compensation has been defined ex-ante for the Group CEO (the sole executive director sitting on the Board of Directors and employee of the Company) and the other Executives with Strategic Responsibilities.

The balance between variable and fixed components has been defined considering also the company's strategic goals, risk management policies and other elements influencing the business of the company.

- Euro 100,000 for the Chairman of Internal Controls and Risks Committee;
- Euro 10,000 for the Chairmen of the other Committees.

At that time, provision was also made for Mr. Saccomanni to be provided accommodation in Milan and cover for health insurance.

The Board of Directors' meeting of September 20, 2019 had confirmed the amount of Euro 775,000, in addition to the insurance coverage for non-occupational accidents, the special remuneration in favour of the new Chairman, Mr. Cesare Bioni. The same Board also had resolved to award Mr. Bioni this special compensation for the period from August 8 to September 19, 2019, during which he served as Chairman while Deputy Chairman.

As required by the "Disposizioni di Vigilanza", the level of remuneration for the Chairman did not exceed the fixed component of the one received by the Chief Executive Officer.

Finally it is recalled that the overall remuneration of the Chief Executive Officer, including the remuneration from employment as General Manager and net of the attendance fees for the participation to Committee meetings, in 2020 was equal to Euro 885,000.

The Shareholders' Meeting of April 2021 is called upon to define the remuneration of the new Board of Directors with regard to both retainer and attendance fees (for further details, see the Directors Report on the "Determination of the remuneration of Directors" available on the institutional website).

**4.1.2 Board of Statutory Auditors**

The Board of Statutory Auditors currently in office was appointed on April 11, 2019 by the Ordinary Shareholders' Meeting and is expected to remain in office for three years, until the approval of the Financial Statements for 2021.

The outgoing Board of Statutory Auditors had provided the Shareholders' Meeting with information on the time commitment required to carry out the assignment. This commitment, for 2018, amounts to 77 days, equal to 616 hours (98 days, equal to 784 hours, as to the Chairman).

In the Shareholders' Report, it was also reminded that the new Board of Statutory Auditors would also perform the functions assigned to the Supervisory Board pursuant to Legislative Decree no. 231 of June 8, 2001, and that, consequently, in the Profile of UniCredit SpA Board of Statutory Auditors it has been estimated as a reference point to assess the overall commitment required to the body's members the number of 109 days a year (98 days for the Board of Statutory Auditors' activities and 11 for the ones of the supervisory body) for the Chairman of the Statutory Auditors and 88 days a year (77 days for the Board of Statutory Auditors' activities and 11 days for the ones of the supervisory body) for the permanent Auditors.



2020 Compensation paid to members of the administrative and auditing bodies, to general managers and to other executives with strategic responsibilities.

2020 Compensation to Directors, Statutory Auditors and Executive with Strategic Responsibilities

Beneficiaries	Remuneration component	Approved by	Amount	Remarks
Non-Executive Directors	Only fixed compensation	Shareholders' Meeting of April 12, 2020	<ul style="list-style-type: none"> <li>€1,740,000, of which €1,125,000 aimed at remunerating the members of the Board and € 615,000 as remuneration of the members of the Board's Committees.</li> <li>Attendance fee for participating to each meeting:</li> <ul style="list-style-type: none"> <li>Board of Directors and Internal Control &amp; Risk Committee: € 1,000</li> <li>In case of physical presence of the Director: € 400</li> <li>In the participation occurs through remote communication means:</li> <ul style="list-style-type: none"> <li>other Board Committees: € 800</li> <li>In case of physical presence of the Director: € 400</li> <li>In the participation occurs through remote communication means.</li> </ul> </ul> </ul>	<p>The compensation is determined on the basis of the importance of the position and the time required for the performance of the tasks assigned.</p> <p>The remuneration is not linked to the economic results achieved by UniCredit, non-executive directors and statutory auditors do not take part in any incentive plans (based on stock options or generally, based on financial instruments).</p> <p>In 2020, after Covid-19 outbreak for safety reason, all meetings were held via remote means and awarded as per the physical presence fee.</p> <p>In 2020, the CEO waived € 3,000,000 to alleviate the impact of the pandemic, therefore the total amounted to € 1,007,000.</p>
Statutory Auditors	Only fixed compensation	Board of Directors of June 13, 2020, pursuant to art. 2389 of the Civil Code par 3 and Article of Association, heard the opinion of Statutory Auditors	<ul style="list-style-type: none"> <li>€1,317,000 for each year of activity, split between:</li> <ul style="list-style-type: none"> <li>• Board Chairman;</li> <li>• Chief Executive Officer (executive);</li> <li>• Chairman of Boards Committees.</li> </ul> </ul>	<p>• Compensation for each year of activity;</p> <ul style="list-style-type: none"> <li>• for the Chairman of Board of Statutory Auditors: € 1,70,000;</li> <li>• for each permanent Auditor: € 125,000;</li> <li>• € 400 attendance fee for participating to each meeting of the Statutory Auditors of the BOD and of the Board Committees.</li> </ul>
Executives with strategic responsibilities	Fixed and variable compensation	Board of Directors	<ul style="list-style-type: none"> <li>2020 compensation level:</li> <ul style="list-style-type: none"> <li>• for the CEO: € 995,000 fixed;</li> <li>• for the other Executives with Strategic Responsibilities:</li> <ul style="list-style-type: none"> <li>• €1,072,992 fixed;</li> <li>• €1,105,000 variable.</li> </ul> </ul> </ul>	<p>For 2020, the maximum ratio between variable and fixed compensation is:</p> <ul style="list-style-type: none"> <li>• 200% for the CEO, the GM and for the Executives with Strategic Responsibilities;</li> <li>• 33% for the Executives with Strategic Responsibilities, responsible for business lines;</li> <li>• 33% for the Executives with Strategic Responsibilities, responsible for Corporate Control Functions;</li> <li>• 100% for the other Executives with Strategic Responsibilities<sup>a</sup></li> </ul>

- Even if meetings are held in the same day.
- Alternate Auditors do not receive any compensation.
- Including the compensation paid for the director relationship (excluding attendance fee).
- For Non-executive directors the fixed remunerations is expected to be pro-rata in respect to the variable one.

Compensation to Directors

Board/Directors	BoD	Internal Control & Risk Committee	Remuneration Committee	Corporate Governance, Nominations and Sustainability Committee	Related Parties Committee	Task fixed comp**	Main remunery benefits	Other remunerations	Task	Fixed value of equity comp.***	T-H	For value of equity comp.***	Severance indemnity for end of office or termination of employment
Cesare Bani	C		C	C		881,651				881,651	881,651		
Lamberto Malvestri	C		C			1,66,200				1,66,200	1,66,200		
Jean Pierre Klerfui - CEO	C					59,800	5,313			90,983	90,983	4,330,059	
Antonio Russo	C					96,000				96,000	96,000		
Stefano Lombardi	C					95,000				95,000	95,000		
Vincenzo Casella	C				C	141,000	9,811			150,811	150,811		
Enrico Cuccini	C	C				224,200				224,200	224,200		
Diego De Greg	C		C			102,374				102,374	102,374		
Isabella de Wames	C		C			25,658				25,658	25,658		
Enrico Luca Marcolini	C					87,228				87,228	87,228		
Stefano Acciani	C			C	C	1,96,200				1,96,200	1,96,200		
Felice Federa	C			C		25,540				25,540	25,540		
Mauro Pericchi	C	C	C		C	217,200				217,200	217,200		
Fabrizio Tassi	C	C	C			227,200				227,200	227,200		
Antonio de Magistris	C	C		C		317,200	9,811			327,011	327,011		
Enrico Zamboni	C		C			1,62,302				1,62,302	1,62,302		
<b>Total Board of Directors</b>						<b>3,185,653</b>		<b>24,936</b>		<b>3,185,653</b>	<b>3,185,653</b>	<b>4,330,059</b>	

- Office held until February 28, 2020.
- Office held since February 5, 2020.
- Office held since November 4, 2020.
- Office held until March 4, 2020.
- Office held since October 15, 2020.
- Office held until October 15, 2020.

Compensation to Statutory Auditors

Board of Statutory Auditors	Chairman	Task fixed comp**	Variable remunery compensation - bonuses and other incentives	Main remunery benefits	Other remunerations	Task	Fixed value of equity comp.***	Severance indemnity for end of office or termination of employment
Mercio Rigotti	Chairman	212,400		11,489			223,889	
Antonio Berini	Standing auditor	155,400		11,489			166,889	
Angelo Bocca Bonisomi	Standing auditor	157,400		11,489			168,889	
Benedetta Novare	Standing auditor	189,200		11,489			190,689	
Guido Rodotà	Standing auditor	174,800		12,197			187,000	
<b>Total Statutory Auditors</b>		<b>890,200</b>		<b>58,653</b>			<b>947,053</b>	

\* Included compensation for committee participation and attendances fees.

\*\* The "Fixed value of equity compensation" does not represent a value actually paid (regardless of equity plans, being instead the cost that the Company is incurring - on an accrual basis - and during the vesting period - in consideration of the provision of the incentives based on financial instruments).

Compensation to Executives with Strategic Responsibilities

Executives with Strategic Responsibilities	Fixed fee: 10,02€131	Variable remuneration: 446,124	No monetary benefits: 372,545	Other remuneration: 1,593,78	Total: 11,066,178	Fair value of equity compensation: 5,08€1,165	Severance payment in the event of termination of employment
Other Executives with Strategic Responsibilities (Total IZ FIE on yearly basis)							

\* The fair value of equity compensation does not represent what we actually paid/gained by the beneficiaries of equity plans, being instead the cost that the company is bearing - on an annual basis and during the vesting period - in conclusion of the provision of the incentives based on financial instruments.

For further details, refer to the Annex 3 document attached to the 2021 Group Remuneration Policy and Report, published on the UniCredit website, in the section dedicated to the Shareholders Meeting.

Development of CEO and Directors total remuneration, average employee remuneration and company performance

Accounting bases	2019	2020	Delta YoY
<b>Chief Executive Officer</b>	2,248 of which: - fixed - fair value of equity	5,241 of which: - fixed - fair value of equity	133% (-25% fixed)
<b>Chairman of the Board of Directors</b>	492	682	79%
<b>Member of the Board of Directors</b>	141 141 87 65 146 178 156 - 192 - 171 155 314 179 154	166 166 96 95 151 224 102 87 196 26 217 227 327 142 224	108% 108% 123% 3% 26% na -84% na 2% na 27% 47% 4% -20% 45%
<b>Chairman of the Statutory Auditors</b>	160	167	5%
<b>Member of the Statutory Auditors</b>	169 190 178	169 200 188	5% 5% 6%
<b>Employees</b>	53	52	-2%
<b>Company Performance (Mln)</b>	4,675	1,264	-73%
<b>CEO to employee ratio</b>	43x (23x fixed)	101x (18x fixed)	+58x (-5x fixed)

As represented in the table and in line with accounting principles, total remuneration including equity fair value considering 2017-2019 ITP in 2020 due to termination of ITP in 2020; total compensation including fair value for fixed components of 2019-2020 long term incentive plan will be lower according to the cliff vesting scheme and subject to tax and other benefits. For further details, refer to the Annex 3 document attached to the 2021 Group Remuneration Policy and Report, published on the UniCredit website, in the section dedicated to the Shareholders Meeting.

- 1. Office held since February 5, 2020
- 2. Office held from March 4, 2020
- 3. Office held since October 13, 2020
- 4. Office held from October 13, 2020

FOCUS

Severance Payments - Members of the Board of Directors, General Managers and other Executives with Strategic Responsibilities

During 2020, no indemnities and/or other benefits were allocated for the termination of office or termination of employment of the members of the administrative and control bodies, General Managers and other Executives with Strategic Responsibilities.

The terms set for the termination of the relationship with the former General Manager and Chief Executive Officer, Mr. Jean Pierre Mustier, were disclosed to the market in press releases issued on December 21, 2020 and February 10, 2021.

Specifically, under the agreements, the terms of which are in line with the Bank's remuneration policy, the term of office of Director and the position of General Manager was terminated with effect from February 11, 2021. The executive employment relationship was terminated on February 28, 2021.

FOCUS

Indemnities to Directors in the event of resignations, dismissal or termination of employment following a public purchase offer (as per Sect. 123/bis, paragraph 1, letter i), of TUF):

None of the Directors have contracts containing clauses envisaging the payment of indemnities, or the right to keep post-retirement benefits, in the event of resignations or dismissal/revocation without just cause or if the employment relationship is terminated following a public purchase offer. In case of early termination of the mandate, the ordinary law provisions would therefore apply.

The individual employment, as Executive, of the Chief Executive Officer, Mr. Jean Pierre Mustier, was governed - also with regards to the event of resignations, dismissal/revocation or termination - by the ordinary provisions of the law and National Labor Agreement for Banking Industry Executives dated July 13, 2015.

FOCUS

Severance Payments - Members of the Board of Directors, General Managers and other Executives with Strategic Responsibilities

Both parties waived any notice period and there was no severance or payment of any other termination benefits other than the mandatory benefits due under the law/collective bargaining agreement as General Manager (i.e. so-called "competenze di fine rapporto").

Mr. Mustier - who, recognizing the priorities of the Bank's stakeholders and as a personal response to the impact of the Covid-19 emergency, had already waived his potential entitlement to the 2020 portion of the bonus in April 2020 - waived any claims against the Bank and the Group, including any entitlements under the 2020-2023 Long Term Incentive Plan ("LTP").

The Bank, in turn, granted Mr. Mustier the right to retain, as a "Good Leaver", his rights under the 2017-2019 Long Term Incentive Plan - corresponding to 486,391 UniCredit shares, based on the performance evaluation carried out by the Board of Directors in February 2020. Under the terms and conditions set forth in the LTP Regulations, the 2017-2019 LTP will vest in 2024 and is subject to malus and claw-back clauses.

FOCUS

Indemnities to Directors in the event of resignations, dismissal or termination of employment following a public purchase offer (as per Sect. 123/bis, paragraph 1, letter i), of TUF):

The aforementioned relationship was terminated at the end of February 2021 without any termination payment other than those strictly due under the law or collective agreement, the so-called "termination fees", consistently with what already announced during a Capital Markets Day held in London on December 13, 2016 for the presentation of the 2016-2019 Strategic Plan *Transfarm 2019* to analysts and investors.

The terms of the exit agreement were disclosed in a Press Release issued on December 21, 2020 pursuant to the Corporate Governance Code.

Non-executive Directors do not receive, within incentive plans, UniCredit subscription rights.

For Directors currently in office, provisions do not exist regarding the establishment of advisory contracts for a term following the termination of the directorship, nor the right to keep post-retirement perks. No agreements exist either providing compensation for non-competition undertakings.

## 4.2 Granular Remuneration Data

Total compensation policy for non-Executive Directors, Group Material Risk Takers and for the overall Group employee population shows in particular how:

- remuneration of the non-Executive Directors, as approved by the AGM, does not include variable performance-related pay;
- variable remuneration for Group Material Risk Takers is in line with their strategic role, regulatory requirements and pay for performance culture;
- the general employee population is offered a balanced pay-mix in line with the role, scope and business or market context of reference.

### Group Material Risk Takers

For 2020 the self-evaluation process, regularly reported in the 2020 Group Remuneration Policy, led to the identification of about 1,000 people at the beginning of 2020.

During 2020 the Group Material Risk Takers list has been constantly updated, taking into account resources turnover and banding and organizational changes review process, bringing the amount of Material Risk Takers to 1,063 by the end of the year.

### Group overall population

The total compensation costs at Group level amounted at 5,968 million Euro in 2020, out of which the variable compensation amounted to 319 million Euro<sup>5</sup>.

Compensation pay-mix by cluster of population/type of business

Group employee population	Compensation Pay-Mix	
	Fixed and other non-performance related Pay	Variable performance-related Pay
Non-Executive Directors	100%	0%
Chairman and Vice-Chairman	100%	0%
Directors	100%	0%
Statutory Auditors	100%	0%
Group employee population	94%	6%
Business Areas <sup>6</sup>	95%	5%
Corporate center/support functions <sup>6</sup>	95%	5%
Overall Group Total	95%	5%

A. Commercial Banking Italy (excluding the local Corporate Center & Commercial Banking Germany) (excluding the local Corporate Center), Commercial Banking Austria (excluding the local Corporate Center), Corporate Center Insurance Banking (excluding the governance functions), C&E, Non-core Corporate Center Global Co-Services, the governance functions in CB and the local Corporate Centers in Italy, Germany and Austria

5. Net of one-off awards.

### Benefits

Furthermore, UniCredit employees enjoyed welfare, healthcare and life balance benefits that supplement social security plans with minimum contractual requirements. These benefits are intended to provide substantial guarantees for the well-being of staff and their family members during their active careers as well as in retirement.

In Italy, among the complementary pension plans, there are defined benefit plans and defined contribution plans. In most cases, benefits are paid out once the retirement requirements are satisfied. In defined benefit plans the benefit's calculation is known in advance, while in defined contribution plans the benefit depends on allocated asset management results.

Complementary pension plans of UniCredit Group in Italy are external pension funds, legally autonomous from the Group.

These plans are closed and do not allow new subscriptions, the only exception is represented by the defined contribution plan section of the "Fondo Pensione per il Personale delle Aziende del Gruppo UniCredit" (which was composed by approximately 45,098 enrolled active employees, as reported in the 2019 Pension Fund Annual Report).

Within this section subscribers can distribute contribution depending on their own risk appetite - among various investment lines (one in the Insurance sector, three in the Finance sector - corresponding to Short, Medium and Long-Term options), characterized by different risk/yield ratios. In addition, the enrolled employees may open complementary pension plan positions in favor of their family members dependent for tax purposes.

Moreover, in most countries where UniCredit is present, complementary pension plans are available for Group employees.

More details and information can be found in the UniCredit Integrated Report and the relevant Supplement.

### 4.2.1 Pillar 3 disclosures on Group Material Risk Takers' remuneration and disclosures on the highest-paid employees

This section contains a number of disclosures which are required in accordance with Article 450 of the Capital Requirements Regulation (CRR) IIF.

Specifically, with reference to table REM 3, the vested component of variable remuneration from previous years refers to cash and equity awards to which the right has been matured as the performance conditions have been achieved:

- the vested components in cash refer to 2015, 2017 and 2019 Group Incentive Systems and, if present, to other forms of variable remuneration;
- the vested components in shares refer to 2016, 2017, 2018 and 2019 Group Incentive Systems and 2017-2019 LTI Plan and, if present, to other forms of variable remuneration.

Instead, the unvested component of variable remuneration from previous years refers to cash and equity awards to which the right has not yet matured and for which any potential future gain has not been yet realized and remains subject to future performance:

- the unvested components in cash refer to 2016, 2017, 2018 and 2019 Group Incentive Systems and, if present, to other forms of variable remuneration;
- the unvested components in shares refer to 2016, 2017, 2018 and 2019 Group Incentive Systems and 2017-2019 LTI Plan and, if present, to other forms of variable remuneration.

The value of the shares shown as unvested equity is calculated considering the arithmetic mean of the official market closing price of UniCredit ordinary shares during the period January 23 - February 23, 2021.

Variable remuneration paid with reference to 2020 from previous years includes payouts based on demonstrated multi-year performance achievements related to Group Incentive Systems plans and, if present, to other forms of variable remuneration.

6. In this context, identified staff and Material Risk Taker are used interchangeably.



**Table 1: EUI 2024 - Remuneration for equity holders**  
 This table describes the main elements of remuneration and how they are implemented in practice. In particular, the following elements were reviewed and checked:

1. <b>Policy</b> The remuneration policy is approved by the Board of Directors and is consistent with the remuneration policy of the parent company. The remuneration policy is approved by the Board of Directors and is consistent with the remuneration policy of the parent company.	2. <b>Structure</b> The remuneration structure is based on fixed and variable components. The fixed component is based on the employee's position and the variable component is based on the employee's performance. The remuneration structure is based on fixed and variable components. The fixed component is based on the employee's position and the variable component is based on the employee's performance.
3. <b>Performance</b> The remuneration is based on the employee's performance. The performance is measured using a variety of metrics, including financial performance, customer satisfaction, and employee engagement. The remuneration is based on the employee's performance. The performance is measured using a variety of metrics, including financial performance, customer satisfaction, and employee engagement.	4. <b>Payment</b> The remuneration is paid in cash and is subject to clawback provisions. The remuneration is paid in cash and is subject to clawback provisions. The remuneration is paid in cash and is subject to clawback provisions.
5. <b>Disclosure</b> The remuneration is disclosed in the annual financial statements. The remuneration is disclosed in the annual financial statements. The remuneration is disclosed in the annual financial statements.	6. <b>Compliance</b> The remuneration is compliant with the applicable laws and regulations. The remuneration is compliant with the applicable laws and regulations. The remuneration is compliant with the applicable laws and regulations.

Template EU REM1 - Remuneration awarded for the financial year

	a	b	c	d
	MB Supervisory function <sup>1</sup>	MB Management function	Other senior management	Other identified staff
1. Number of identified staff	13	1	285	777
2. Total fixed remuneration	2,459	893	1,014,96	154,192
3. Of which: cash-based	2,439	885	873,941	119,962
4. Not applicable in the EU	-	-	-	-
5. Fixed remuneration	-	-	-	-
6. Of which: share-linked instruments or equivalent non-cash instruments	-	-	-	-
7. Of which: other forms <sup>2</sup>	-	-	-	-
8. Not applicable in the EU	20	B	1,41,58	1,54,10
9. Number of identified staff	13	1	285	777
10. Total variable remuneration	-	-	21,786	44,671
11. Of which: cash-based	-	-	11,132	27,105
12. Of which: deferred	-	-	4,291	7,379
13. Of which: share-linked instruments or equivalent non-cash instruments	-	-	10,218	17,102
14. Of which: deferred	-	-	6,015	7,596
15. Variable remuneration	-	-	372	-
16. Of which: deferred	-	-	177	-
17. Of which: other forms <sup>2</sup>	-	-	-	-
18. Of which: deferred	-	-	-	-
19. Of which: other forms <sup>2</sup>	-	-	66	64
20. Of which: deferred	-	-	-	-
21. Total remuneration (2 + 10)	2,459	893	1,232,86	199,063

DATA IN EUR

Note: fixed and variable remuneration includes non-standard compensation awarded in the reference year and excludes severance payments which are reported in REM 2 table

<sup>1</sup> Number of MB in Supervisory Function in Full Time Equivalent (see Consol tables)  
<sup>2</sup> Value related to a sub-set of benefits (accommodation, accommodation allowance, company car/cash equivalent to a sustainable mobility, health coverage/insurance, integrative pension fund), assigned according to Group policies. Values are estimated, based on the costs borne by the Company to grant the mentioned benefits; amounts are net, gross only if defined as such within the policies.

Template EU REM2 - Special payments to staff whose professional activities have a material impact on institutions' risk profile (identified staff)

	a	b	c	d
	MB Supervisory function	MB Management function	Other senior management	Other identified staff
1. Total fixed remuneration	0	0	200	210
2. Of which: cash-based	0	0	200	210
3. Not applicable in the EU	0	0	0	0
4. Fixed remuneration	0	0	48	22
5. Of which: share-linked instruments or equivalent non-cash instruments	0	0	3,300	1,000
6. Of which: deferred	0	0	1,300	20
7. Variable remuneration	0	0	13,200	6,900
8. Of which: cash-based	0	0	6,700	2,000
9. Of which: deferred	0	0	6,500	4,900
10. Total remuneration	0	0	13,400	7,122
11. Of which: deferred	0	0	13,400	7,122

DATA IN EUR

Note: for the severance payments awarded in previous periods, please refer to the table in the table below



Banking that matters. |  **UniCredit**

[unicreditgroup.eu](https://unicreditgroup.eu)